

ECOHiLUX照明器具 配光データシート

意匠図

器具品名	高天井LED照明	保守率	
器具品番	CL5M-200W-90-K40-R7-D-V2	良	0.69
部品品名	-	中	0.67
部品品番	-	否	0.63
器具光束	34200lm	器具効率	
光源	LED	上方向	0%
光源光束	一体型器具のため、器具光束表示	下方向	100%
		全方向	100%

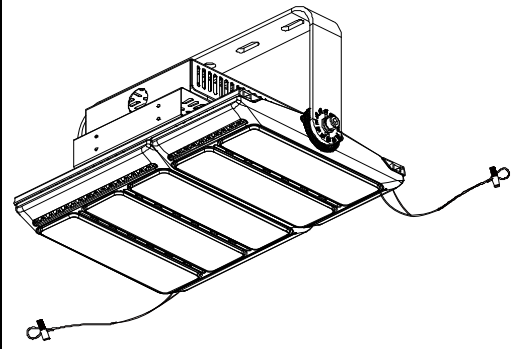

照明率表

		作業面照明率(×0.01)																								
反射率	天井	80								70				50				30		0						
		壁		70		50		30		10		70		50		30		10		30		10		0		
	床	30	10	30	10	30	10	10	30	10	30	10	30	10	10	30	10	30	10	30	10	10	30	10	10	0
室 指 数	0.4	53	50	41	39	34	33	29	52	49	40	39	34	33	29	39	38	33	33	29	33	32	29	27		
	0.6	71	66	58	55	50	49	44	70	65	57	55	50	49	44	56	54	49	48	44	48	48	44	42		
	0.8	83	75	70	66	62	60	55	81	74	69	65	61	59	55	67	64	60	58	54	59	58	54	52		
	1	91	82	79	73	71	67	62	89	80	78	72	70	67	62	75	71	68	66	62	67	65	61	59		
	1.25	98	88	87	80	79	74	70	96	86	85	79	78	74	70	82	77	76	73	69	74	72	68	66		
	1.5	104	91	93	85	85	79	75	100	90	91	84	84	79	75	87	82	81	77	74	79	76	73	71		
	2	110	96	101	90	94	86	82	107	94	99	89	92	85	82	94	87	89	84	81	86	82	80	77		
	2.5	114	99	107	94	100	90	87	111	97	104	93	98	89	86	98	91	94	88	85	90	86	84	82		
	3	117	100	110	97	104	93	90	113	99	107	95	102	92	90	101	93	97	91	88	93	89	87	84		
	4	121	103	115	100	110	97	95	117	101	112	99	107	96	94	105	96	102	94	92	97	92	91	88		
5	123	104	118	102	114	99	97	119	103	115	100	111	98	96	108	98	105	96	95	99	94	93	90			
7	126	106	122	104	119	102	100	121	104	118	103	115	101	100	110	100	108	99	98	102	97	96	93			
10	128	107	125	105	123	104	103	123	105	121	104	118	103	102	113	102	111	101	100	104	99	98	95			

配光曲線

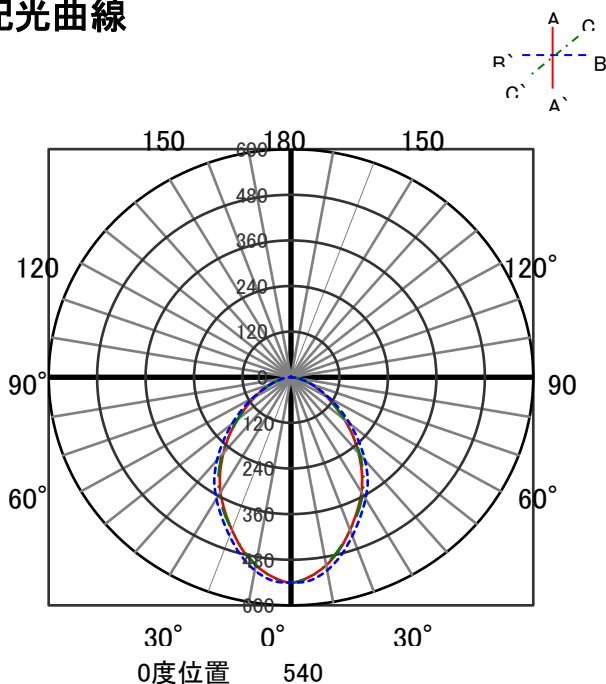

直射水平面照度

