

ECOHiLUX照明器具 配光データシート

意匠図

器具品名	コンパクト蛍光灯LED代替器具 55形3灯	保守率	
器具品番	CPB55-CL3-O2	良	0.81
部品品名	-	中	0.77
部品品番	-	否	0.68
器具光束	6305lm	器具効率	
光源	LDCP55N/15/22-O	上方向	0%
光源光束	2200lm × 3	下方向	96%
		全方向	96%

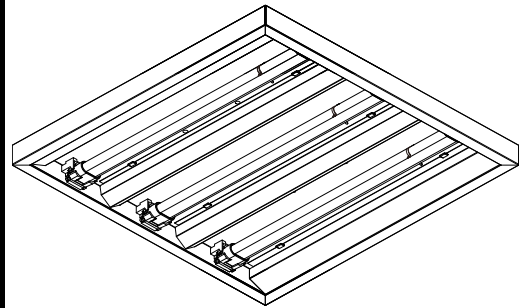

照明率表

		作業面照明率(×0.01)																								
反射率	天井	80								70				50				30		0						
		壁		70		50		30		10		70		50		30		10		30		10		0		
	床	30	10	30	10	30	10	10	30	10	30	10	30	10	10	30	10	30	10	10	30	10	10	30	10	0
室 指 数	0.4	46	43	32	31	24	24	19	44	42	31	30	24	24	19	30	30	24	23	19	23	23	19	17		
	0.6	63	58	48	46	39	38	33	61	56	47	45	39	38	32	46	44	38	37	32	37	36	32	30		
	0.8	73	66	58	54	48	46	40	71	65	57	53	47	46	40	54	52	46	45	40	45	44	39	37		
	1	82	73	67	62	57	54	48	79	72	65	61	56	54	48	63	59	55	53	47	53	52	47	45		
	1.25	90	80	76	70	66	62	57	87	78	74	69	65	62	56	71	67	63	61	56	61	60	55	52		
	1.5	95	84	82	75	73	67	62	92	82	80	74	71	67	61	76	71	69	65	60	66	64	60	57		
	2	103	90	92	82	83	75	70	99	88	89	81	81	75	70	84	78	77	73	69	74	72	68	65		
	2.5	108	94	98	87	90	81	76	104	92	95	86	88	80	76	90	83	84	79	75	80	77	74	71		
	3	112	96	103	90	95	85	81	108	94	100	89	93	84	80	94	86	88	82	79	84	81	78	75		
	4	117	99	109	95	103	90	87	112	97	106	93	100	89	86	99	91	94	87	84	90	85	83	80		
5	120	101	113	97	108	94	91	115	100	109	96	105	93	90	103	93	99	91	88	93	89	86	83			
7	123	103	118	101	114	98	95	118	102	114	99	110	97	94	107	97	104	95	93	98	92	91	88			
10	126	105	122	103	119	101	99	121	104	118	102	115	100	98	110	99	107	98	96	101	95	94	91			

配光曲線

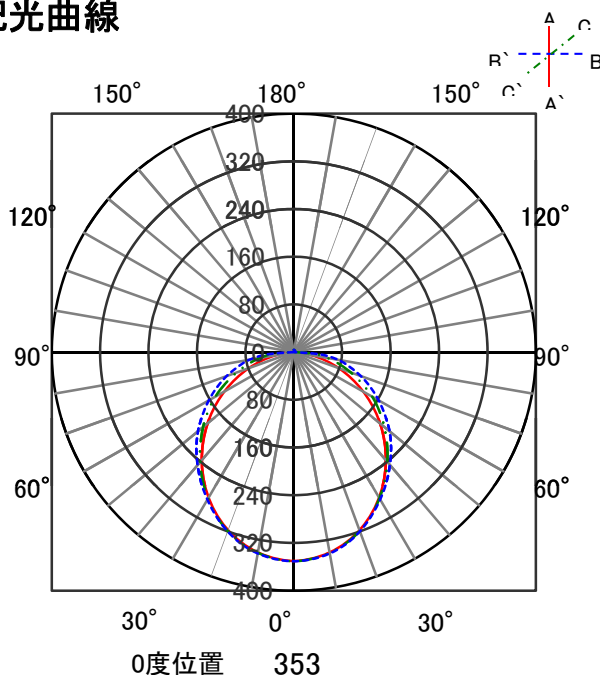

直射水平面照度

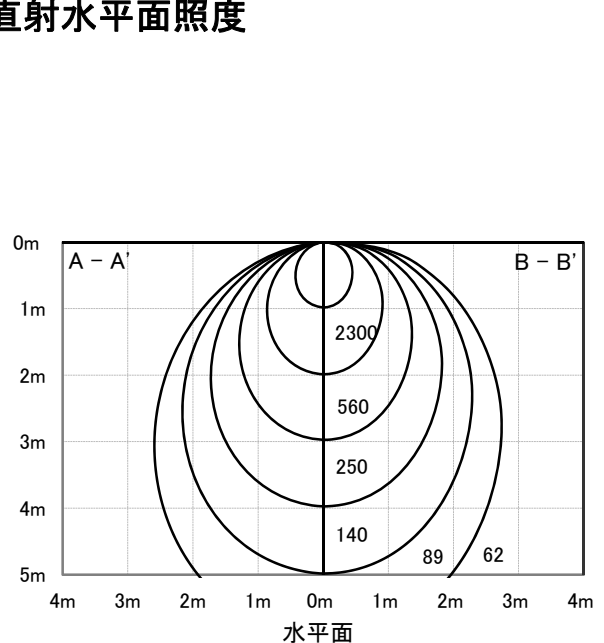

ECOHiLUX照明器具 配光データシート

意匠図

器具品名	コンパクト蛍光灯LED代替器具 55形4灯	保守率	
器具品番	CPB55-CL4-O2	良	0.81
部品品名	-	中	0.77
部品品番	-	否	0.68
器具光束	8410lm	器具効率	
光源	LDCP55N/15/22-O	上方向	0%
光源光束	2200lm × 4	下方向	96%
		全方向	96%

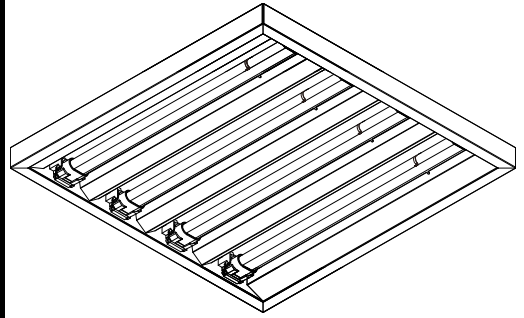

照明率表

		作業面照明率(×0.01)																						
反射率	天井	80								70				50				30		0				
	壁	70	50	30	10	70	50	30	10	70	50	30	10	50	30	10	30	10	30	10	10	0		
	床	30	10	30	10	30	10	10	30	10	30	10	30	10	10	30	10	30	10	30	10	10	0	
室 指 数	0.4	45	43	32	31	24	24	19	44	42	31	30	24	23	19	30	29	24	23	19	23	23	19	17
	0.6	62	58	48	45	39	38	32	61	56	47	45	38	37	32	45	43	38	37	32	37	36	32	30
	0.8	73	66	57	54	48	46	40	70	64	56	53	47	45	40	54	52	46	45	39	45	44	39	37
	1	81	73	67	62	57	54	48	79	71	65	61	56	53	47	62	59	54	52	47	53	51	47	44
	1.25	90	80	76	70	66	62	56	87	78	74	69	65	61	56	71	67	63	60	55	61	59	55	52
	1.5	95	84	82	74	72	67	61	92	82	80	73	71	66	61	76	71	68	65	60	66	64	59	57
	2	103	89	91	82	82	75	70	99	88	89	80	80	74	69	84	78	77	73	68	74	71	67	64
	2.5	108	93	98	87	90	81	76	104	92	95	85	88	80	76	90	83	84	78	74	80	77	73	70
	3	112	96	103	90	95	85	80	108	94	99	89	93	84	80	94	86	88	82	78	84	80	77	74
	4	116	99	109	94	102	90	86	112	97	105	93	100	89	86	99	90	94	87	84	89	85	83	80
5	119	101	113	97	108	94	90	115	99	109	96	104	93	90	102	93	98	90	88	93	88	86	83	
7	123	103	118	100	114	98	95	118	102	114	99	110	97	94	106	97	103	94	92	97	92	91	87	
10	126	105	122	103	119	101	99	121	104	118	102	115	100	98	110	99	107	98	96	101	95	94	91	

配光曲線

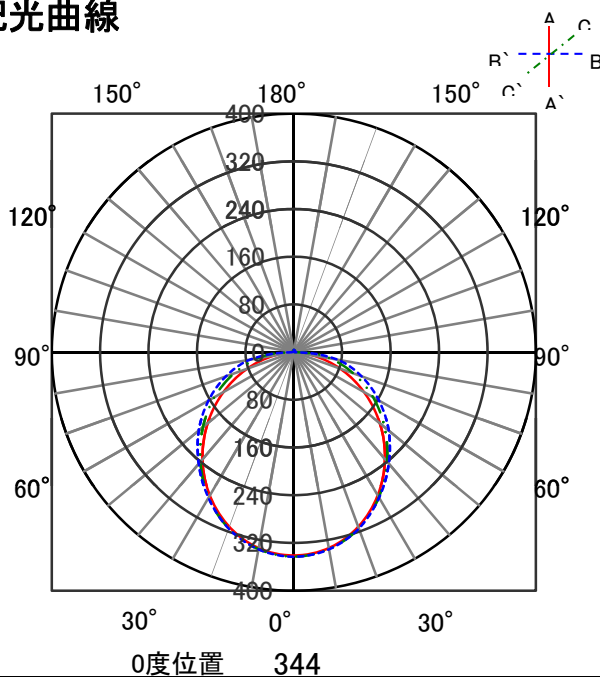

直射水平面照度

