

ECOHiLUX照明器具 配光データシート

意匠図

| | | | |
|------|-------------------------|------|------|
| 器具品名 | 直管用専用器具 直付下面開放型40形1灯 | 保守率 | |
| 器具品番 | IRLDL41CL-K | 良 | 0.69 |
| 部品品名 | - | 中 | 0.67 |
| 部品品番 | - | 否 | 0.63 |
| | | 器具効率 | |
| 器具光束 | 2120lm | 上方向 | 0% |
| 光源 | LDG32T・WW/14/23/19SV/RK | 下方向 | 90% |
| 光源光束 | 2350lm | 全方向 | 90% |

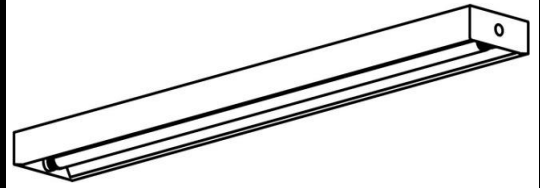

照明率表

| | | 作業面照明率(×0.01) | | | | | | | | | | | | | | | | | | | | | | |
|-------------|--------------|---------------|-----|-----|-----|----|----|-----|-----|-----|----|-----|----|----|-----|----|-----|----|----|----|----|----|----|----|
| 反射率 | 天井 壁 床 | 80 | | | | | | | | 70 | | | | | | | | 50 | | | | 30 | | 0 |
| | | 70 | 10 | 30 | 50 | 10 | 30 | 10 | 10 | 70 | 10 | 30 | 50 | 10 | 30 | 10 | 10 | 50 | 30 | 10 | 10 | 30 | 10 | 0 |
| 室 指 数 | 0.4 | 41 | 39 | 28 | 27 | 21 | 21 | 16 | 40 | 38 | 28 | 27 | 21 | 20 | 16 | 27 | 26 | 20 | 20 | 16 | 20 | 20 | 16 | 15 |
| | 0.6 | 57 | 52 | 43 | 40 | 34 | 33 | 28 | 55 | 51 | 42 | 40 | 34 | 33 | 28 | 40 | 39 | 33 | 32 | 28 | 32 | 32 | 27 | 26 |
| | 0.8 | 66 | 60 | 52 | 48 | 42 | 41 | 35 | 64 | 59 | 51 | 48 | 42 | 40 | 35 | 49 | 46 | 41 | 40 | 34 | 40 | 39 | 34 | 32 |
| | 1 | 74 | 67 | 60 | 56 | 50 | 48 | 42 | 72 | 65 | 59 | 55 | 50 | 47 | 42 | 56 | 53 | 48 | 47 | 42 | 47 | 46 | 41 | 39 |
| | 1.25 | 82 | 73 | 69 | 63 | 59 | 56 | 50 | 79 | 71 | 67 | 62 | 58 | 55 | 50 | 64 | 60 | 56 | 54 | 49 | 55 | 53 | 49 | 46 |
| | 1.5 | 87 | 77 | 74 | 68 | 65 | 60 | 55 | 84 | 75 | 72 | 67 | 64 | 60 | 54 | 69 | 65 | 62 | 59 | 54 | 60 | 58 | 53 | 51 |
| | 2 | 95 | 82 | 83 | 74 | 75 | 68 | 63 | 91 | 81 | 81 | 73 | 73 | 67 | 62 | 77 | 71 | 70 | 66 | 62 | 67 | 65 | 61 | 58 |
| | 2.5 | 100 | 86 | 90 | 79 | 82 | 74 | 69 | 96 | 84 | 87 | 78 | 80 | 73 | 68 | 82 | 76 | 76 | 72 | 68 | 73 | 70 | 67 | 64 |
| | 3 | 103 | 88 | 94 | 83 | 87 | 78 | 73 | 99 | 87 | 91 | 81 | 85 | 77 | 73 | 86 | 79 | 81 | 75 | 71 | 77 | 74 | 70 | 68 |
| | 4 | 108 | 92 | 100 | 87 | 94 | 83 | 79 | 104 | 90 | 97 | 86 | 91 | 82 | 78 | 91 | 83 | 87 | 80 | 77 | 82 | 79 | 76 | 73 |
| 5 | 111 | 94 | 105 | 90 | 99 | 86 | 83 | 106 | 92 | 101 | 89 | 96 | 85 | 82 | 95 | 86 | 91 | 83 | 81 | 86 | 82 | 79 | 77 | |
| 7 | 114 | 96 | 109 | 93 | 105 | 90 | 88 | 110 | 94 | 106 | 92 | 102 | 89 | 87 | 99 | 90 | 96 | 87 | 85 | 90 | 86 | 84 | 81 | |
| 10 | 117 | 98 | 113 | 96 | 110 | 93 | 92 | 112 | 96 | 109 | 94 | 106 | 92 | 91 | 102 | 92 | 100 | 90 | 89 | 94 | 89 | 87 | 84 | |

配光曲線

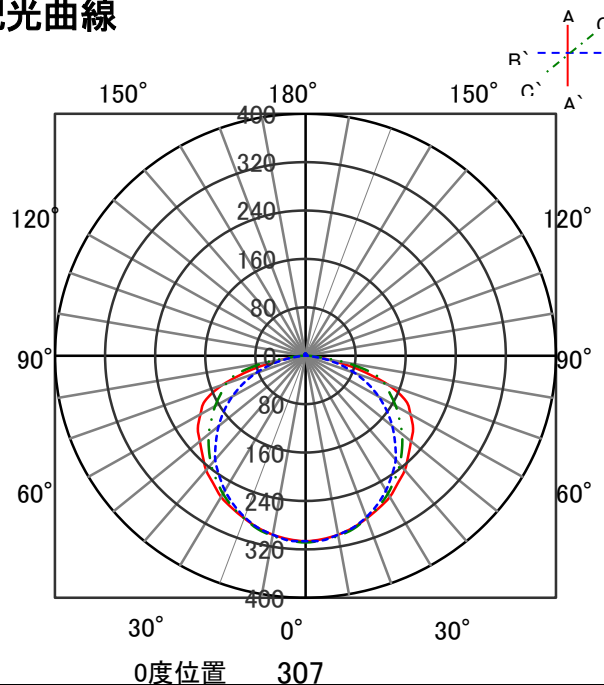

直射水平面照度

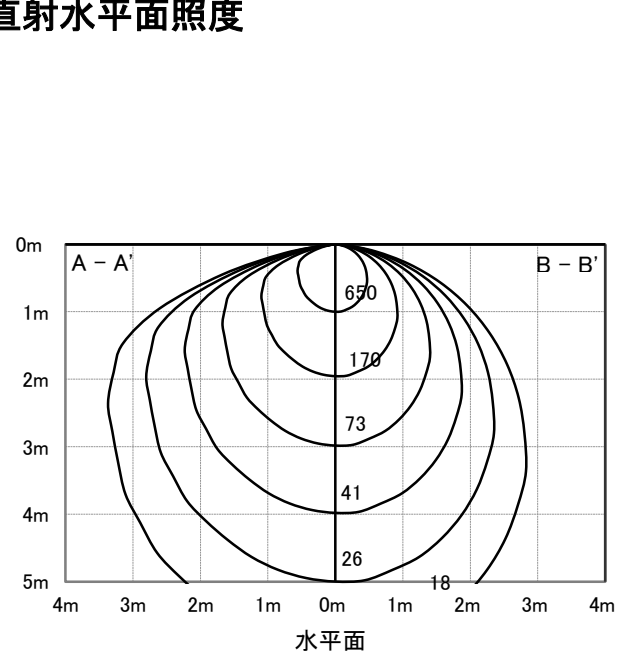

ECOHiLUX照明器具 配光データシート

意匠図

| | | | |
|------|-------------------------|------|------|
| 器具品名 | 直管用専用器具 逆富士型40形1灯 | 保守率 | |
| 器具品番 | IRLDFL41FJ-K | 良 | 0.69 |
| 部品品名 | - | 中 | 0.67 |
| 部品品番 | - | 否 | 0.63 |
| 器具光束 | 2160lm | 器具効率 | |
| 光源 | LDG32T・WW/14/23/19SV/RK | 上方向 | 8% |
| 光源光束 | 2350lm | 下方向 | 84% |
| | | 全方向 | 92% |

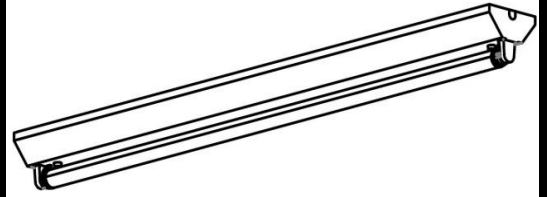

照明率表

| | | 作業面照明率(×0.01) | | | | | | | | | | | | | | | | | | | | | | | | | | | | | |
|-------------|--------------|---------------|-----|-----|-----|----|----|-----|-----|-----|-----|-----|----|----|-----|----|-----|----|----|----|----|----|----|----|----|----|----|----|---|----|----|
| 反射率 | 天井 壁 床 | 80 | | | | | | | | 70 | | | | | | | | 50 | | | | 30 | | | | 0 | | | | | |
| | | 70 | 10 | 30 | 10 | 30 | 10 | 10 | 10 | 70 | 10 | 30 | 10 | 30 | 10 | 10 | 10 | 50 | 10 | 30 | 10 | 10 | 30 | 10 | 10 | 30 | 10 | 10 | 0 | 30 | 10 |
| 室 指 数 | 0.4 | 43 | 41 | 29 | 28 | 22 | 21 | 17 | 42 | 39 | 29 | 28 | 21 | 21 | 17 | 27 | 26 | 21 | 20 | 16 | 20 | 20 | 16 | 14 | | | | | | | |
| | 0.6 | 59 | 55 | 44 | 42 | 35 | 34 | 29 | 57 | 53 | 43 | 41 | 35 | 34 | 28 | 41 | 39 | 33 | 32 | 28 | 32 | 31 | 27 | 24 | | | | | | | |
| | 0.8 | 69 | 63 | 54 | 50 | 44 | 42 | 36 | 66 | 61 | 52 | 49 | 43 | 41 | 35 | 49 | 47 | 41 | 40 | 35 | 39 | 38 | 34 | 31 | | | | | | | |
| | 1 | 78 | 70 | 62 | 58 | 52 | 50 | 43 | 74 | 67 | 61 | 57 | 51 | 49 | 43 | 57 | 54 | 49 | 47 | 42 | 46 | 45 | 40 | 37 | | | | | | | |
| | 1.25 | 86 | 76 | 71 | 65 | 61 | 57 | 51 | 82 | 74 | 69 | 64 | 60 | 56 | 50 | 65 | 61 | 57 | 54 | 49 | 54 | 52 | 48 | 44 | | | | | | | |
| | 1.5 | 91 | 80 | 77 | 70 | 67 | 62 | 56 | 87 | 78 | 75 | 68 | 65 | 61 | 55 | 70 | 65 | 62 | 59 | 54 | 59 | 57 | 52 | 48 | | | | | | | |
| | 2 | 99 | 86 | 87 | 77 | 77 | 70 | 64 | 94 | 83 | 83 | 76 | 75 | 69 | 64 | 77 | 72 | 70 | 66 | 62 | 66 | 64 | 60 | 56 | | | | | | | |
| | 2.5 | 104 | 90 | 93 | 83 | 85 | 76 | 71 | 99 | 87 | 90 | 81 | 82 | 75 | 70 | 83 | 77 | 77 | 72 | 68 | 72 | 69 | 65 | 61 | | | | | | | |
| | 3 | 108 | 92 | 98 | 86 | 90 | 80 | 75 | 103 | 90 | 94 | 84 | 87 | 79 | 74 | 87 | 80 | 81 | 76 | 72 | 76 | 73 | 69 | 65 | | | | | | | |
| | 4 | 113 | 96 | 105 | 90 | 97 | 86 | 81 | 107 | 93 | 100 | 88 | 94 | 84 | 80 | 92 | 84 | 87 | 81 | 77 | 81 | 78 | 75 | 70 | | | | | | | |
| 5 | 116 | 98 | 109 | 93 | 103 | 89 | 85 | 110 | 95 | 104 | 91 | 99 | 88 | 84 | 96 | 87 | 91 | 84 | 81 | 85 | 81 | 78 | 73 | | | | | | | | |
| 7 | 120 | 100 | 114 | 97 | 109 | 94 | 91 | 114 | 98 | 109 | 95 | 105 | 92 | 89 | 100 | 91 | 97 | 88 | 86 | 89 | 85 | 83 | 78 | | | | | | | | |
| 10 | 122 | 102 | 118 | 100 | 115 | 97 | 95 | 117 | 100 | 113 | 98 | 110 | 95 | 93 | 104 | 94 | 101 | 92 | 90 | 93 | 88 | 86 | 81 | | | | | | | | |

配光曲線

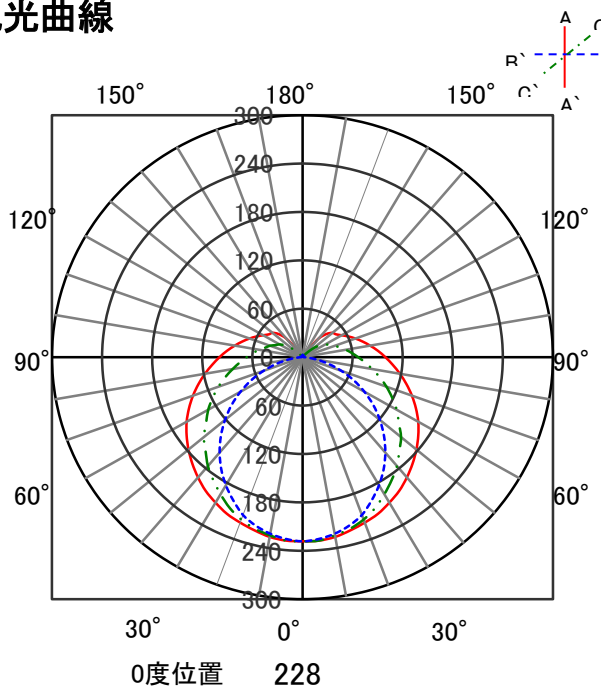

直射水平面照度

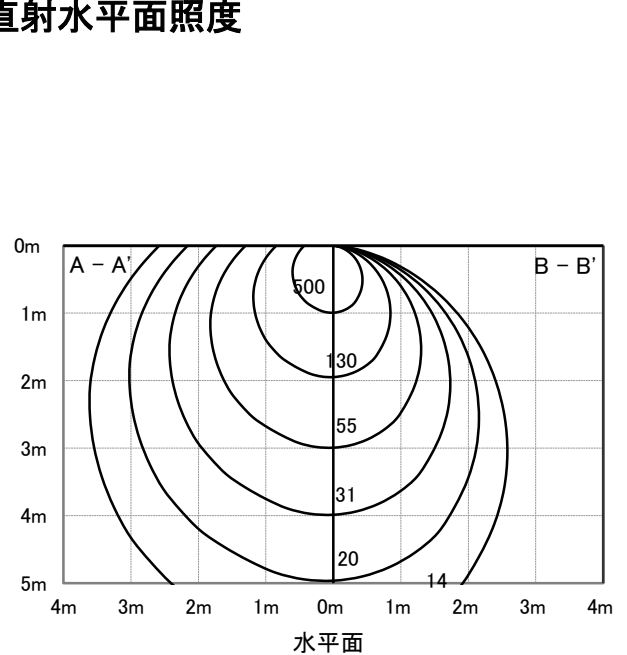

ECOHiLUX照明器具 配光データシート

意匠図

| | | | |
|------|-------------------------|------|------|
| 器具品名 | 直管用専用器具 トラフ型40形1灯 | 保守率 | |
| 器具品番 | IRLDL41TR-K | 良 | 0.69 |
| 部品品名 | - | 中 | 0.67 |
| 部品品番 | - | 否 | 0.63 |
| | | 器具効率 | |
| 器具光束 | 2160lm | 上方向 | 8% |
| 光源 | LDG32T-WW/14/23/19SV/RK | 下方向 | 84% |
| 光源光束 | 2350lm | 全方向 | 92% |

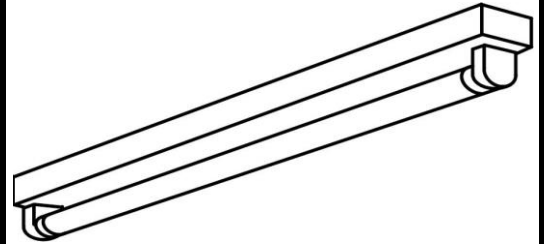

照明率表

| | | 作業面照明率(×0.01) | | | | | | | | | | | | | | | | | | | | | | |
|-----|------|---------------|-----|-----|----|-----|----|----|-----|----|-----|----|-----|----|----|-----|----|----|----|----|----|----|----|----|
| 反射率 | 天井 | 80 | | | | | | | | 70 | | | | 50 | | | | 30 | | 0 | | | | |
| | 壁 | 70 | 10 | 30 | 10 | 30 | 10 | 10 | 30 | 10 | 30 | 10 | 30 | 10 | 30 | 10 | 30 | 10 | 30 | 10 | 0 | | | |
| 室 | 0.4 | 42 | 40 | 29 | 28 | 21 | 21 | 16 | 41 | 38 | 28 | 27 | 21 | 21 | 16 | 27 | 26 | 20 | 20 | 16 | 19 | 19 | 15 | 13 |
| | 0.6 | 58 | 54 | 43 | 41 | 34 | 33 | 28 | 56 | 52 | 42 | 40 | 34 | 33 | 27 | 40 | 38 | 32 | 32 | 27 | 31 | 30 | 26 | 23 |
| | 0.8 | 68 | 62 | 53 | 49 | 43 | 41 | 35 | 65 | 60 | 51 | 48 | 42 | 40 | 34 | 48 | 46 | 40 | 39 | 34 | 38 | 37 | 33 | 30 |
| | 1 | 76 | 68 | 61 | 57 | 51 | 48 | 42 | 73 | 66 | 59 | 55 | 50 | 48 | 42 | 56 | 53 | 48 | 46 | 40 | 45 | 44 | 39 | 36 |
| | 1.25 | 84 | 75 | 70 | 64 | 60 | 56 | 50 | 81 | 72 | 68 | 63 | 58 | 55 | 49 | 63 | 60 | 55 | 53 | 48 | 53 | 51 | 47 | 43 |
| | 1.5 | 90 | 79 | 76 | 69 | 66 | 61 | 55 | 85 | 76 | 73 | 67 | 64 | 60 | 54 | 68 | 64 | 61 | 58 | 53 | 57 | 55 | 51 | 47 |
| | 2 | 97 | 85 | 85 | 76 | 76 | 69 | 63 | 93 | 82 | 82 | 74 | 73 | 68 | 62 | 76 | 71 | 69 | 65 | 60 | 65 | 63 | 58 | 54 |
| | 2.5 | 103 | 89 | 92 | 81 | 83 | 75 | 70 | 98 | 86 | 88 | 79 | 80 | 73 | 68 | 82 | 76 | 75 | 71 | 66 | 71 | 68 | 64 | 60 |
| | 3 | 106 | 91 | 97 | 85 | 88 | 79 | 74 | 101 | 89 | 93 | 83 | 85 | 77 | 73 | 85 | 79 | 80 | 74 | 70 | 75 | 71 | 68 | 63 |
| | 4 | 111 | 94 | 103 | 89 | 96 | 84 | 80 | 106 | 92 | 99 | 87 | 92 | 83 | 79 | 91 | 83 | 86 | 79 | 76 | 80 | 76 | 73 | 68 |
| | 5 | 114 | 97 | 107 | 92 | 101 | 88 | 84 | 109 | 94 | 103 | 90 | 97 | 86 | 83 | 94 | 86 | 90 | 83 | 80 | 84 | 79 | 77 | 72 |
| | 7 | 118 | 99 | 112 | 96 | 108 | 92 | 89 | 112 | 97 | 108 | 93 | 103 | 90 | 88 | 99 | 89 | 95 | 87 | 84 | 88 | 83 | 81 | 76 |
| | 10 | 121 | 101 | 117 | 98 | 113 | 96 | 94 | 115 | 99 | 111 | 96 | 108 | 94 | 92 | 102 | 92 | 99 | 90 | 88 | 92 | 87 | 85 | 80 |

配光曲線

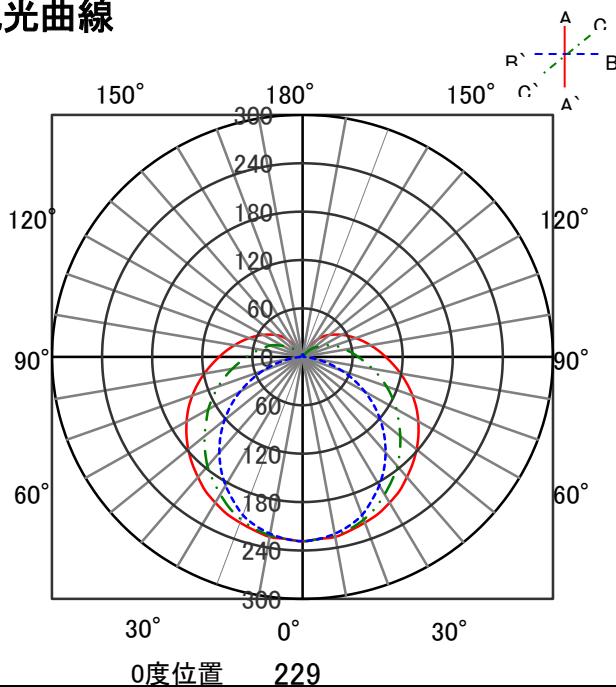

直射水平面照度

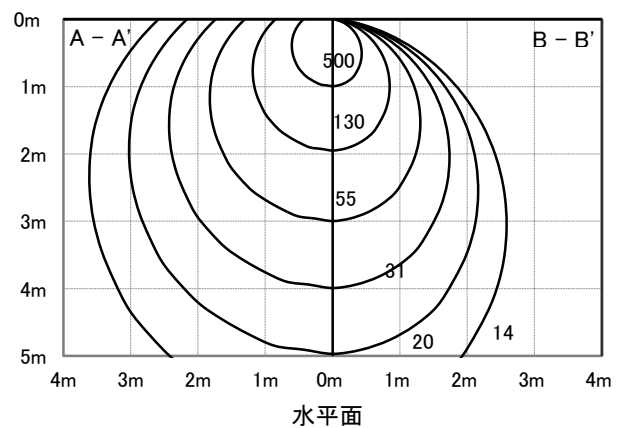

ECOHiLUX照明器具 配光データシート

意匠図

| | | | |
|------|-------------------------|------|------|
| 器具品名 | 直管用専用器具 直付下面開放型40形1灯 | 保守率 | |
| 器具品番 | IRLDLFL41UK-K | 良 | 0.69 |
| 部品品名 | - | 中 | 0.67 |
| 部品品番 | - | 否 | 0.63 |
| 器具光束 | 2190lm | 器具効率 | |
| 光源 | LDG32T-WW/14/23/19SV/RK | 上方向 | 0% |
| 光源光束 | 2350lm | 下方向 | 93% |
| | | 全方向 | 93% |

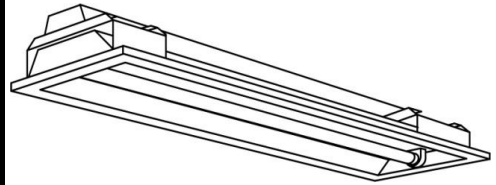

照明率表

| | | 作業面照明率(×0.01) | | | | | | | | | | | | | | | | | | | | | | | | | | | | | | |
|-------------|------|---------------|-----|----|-----|----|----|-----|----|-----|----|-----|----|----|----|----|----|----|----|----|----|----|----|----|----|----|----|----|----|----|--|--|
| 反射率 | 天井 | 80 | | | | | | | | 70 | | | | 50 | | | | 30 | | | | 0 | | | | | | | | | | |
| | | 壁 | | 70 | | 50 | | 30 | | 10 | | 70 | | 50 | | 30 | | 10 | | 50 | | 30 | | 10 | | 30 | | 10 | | 0 | | |
| | 床 | 30 | 10 | 30 | 10 | 30 | 10 | 10 | 30 | 10 | 30 | 10 | 30 | 10 | 10 | 30 | 10 | 30 | 10 | 10 | 30 | 10 | 30 | 10 | 10 | 30 | 10 | 30 | 10 | 10 | | |
| 室 指 数 | 0.4 | 39 | 37 | 27 | 26 | 20 | 19 | 15 | 38 | 36 | 26 | 25 | 20 | 19 | 15 | 25 | 25 | 19 | 19 | 15 | 19 | 19 | 15 | 14 | | | | | | | | |
| | 0.6 | 54 | 50 | 40 | 38 | 32 | 31 | 26 | 52 | 48 | 40 | 38 | 32 | 31 | 26 | 38 | 37 | 31 | 31 | 26 | 31 | 30 | 26 | 24 | | | | | | | | |
| | 0.8 | 63 | 57 | 49 | 46 | 40 | 39 | 33 | 61 | 56 | 48 | 45 | 40 | 38 | 33 | 46 | 44 | 39 | 38 | 33 | 38 | 37 | 32 | 30 | | | | | | | | |
| | 1 | 71 | 64 | 57 | 53 | 48 | 46 | 40 | 68 | 62 | 56 | 52 | 47 | 45 | 40 | 53 | 51 | 46 | 44 | 39 | 45 | 44 | 39 | 37 | | | | | | | | |
| | 1.25 | 78 | 69 | 66 | 60 | 56 | 53 | 47 | 75 | 68 | 64 | 59 | 55 | 52 | 47 | 61 | 57 | 54 | 51 | 47 | 52 | 51 | 46 | 44 | | | | | | | | |
| | 1.5 | 83 | 73 | 71 | 64 | 62 | 57 | 52 | 80 | 72 | 69 | 63 | 61 | 57 | 52 | 66 | 62 | 59 | 56 | 51 | 57 | 55 | 51 | 48 | | | | | | | | |
| | 2 | 90 | 78 | 80 | 71 | 71 | 65 | 60 | 87 | 77 | 77 | 70 | 70 | 64 | 59 | 73 | 68 | 67 | 63 | 59 | 64 | 62 | 58 | 56 | | | | | | | | |
| | 2.5 | 95 | 82 | 86 | 76 | 78 | 70 | 66 | 92 | 81 | 83 | 75 | 76 | 70 | 65 | 79 | 73 | 73 | 68 | 64 | 70 | 67 | 64 | 61 | | | | | | | | |
| | 3 | 98 | 84 | 90 | 79 | 83 | 74 | 70 | 95 | 83 | 87 | 78 | 81 | 73 | 69 | 82 | 76 | 77 | 72 | 68 | 73 | 70 | 67 | 65 | | | | | | | | |
| | 4 | 103 | 87 | 96 | 83 | 90 | 79 | 75 | 99 | 86 | 93 | 82 | 87 | 78 | 75 | 87 | 80 | 83 | 76 | 74 | 79 | 75 | 72 | 70 | | | | | | | | |
| 5 | 106 | 89 | 100 | 86 | 95 | 82 | 79 | 102 | 88 | 96 | 85 | 92 | 81 | 78 | 90 | 82 | 87 | 80 | 77 | 82 | 78 | 76 | 73 | | | | | | | | | |
| 7 | 109 | 92 | 104 | 89 | 100 | 86 | 84 | 105 | 90 | 101 | 88 | 97 | 85 | 83 | 94 | 86 | 91 | 83 | 81 | 86 | 82 | 80 | 77 | | | | | | | | | |
| 10 | 112 | 93 | 108 | 91 | 105 | 89 | 87 | 107 | 92 | 104 | 90 | 102 | 88 | 87 | 97 | 88 | 95 | 86 | 85 | 90 | 85 | 83 | 81 | | | | | | | | | |

配光曲線

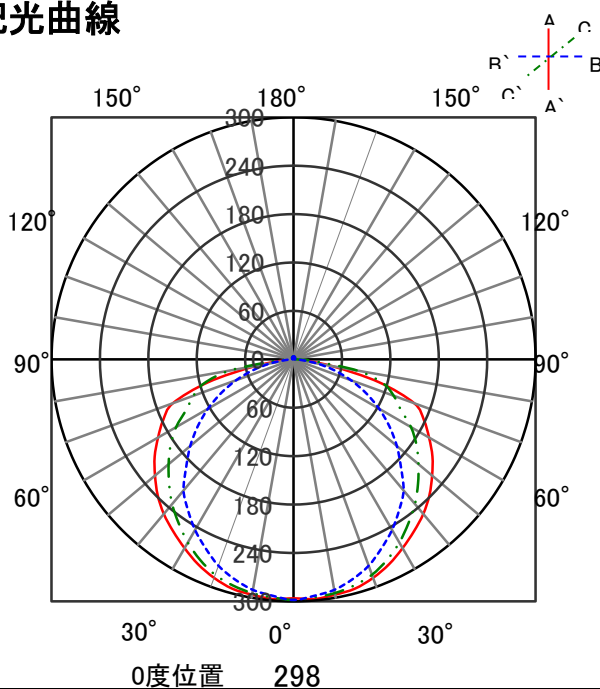

直射水平面照度

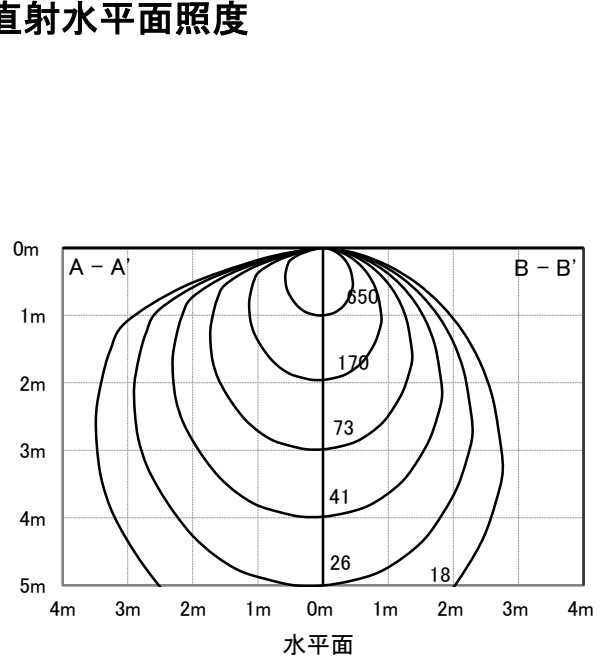

ECOHiLUX照明器具 配光データシート

意匠図

| | | | |
|------|-------------------------|------|------|
| 器具品名 | 直管用専用器具 直付下面開放型40形2灯 | 保守率 | |
| 器具品番 | IRLDL42CL-K | 良 | 0.81 |
| 部品品名 | - | 中 | 0.77 |
| 部品品番 | - | 否 | 0.67 |
| 器具光束 | 2210lm | 器具効率 | |
| 光源 | LDG32T・WW/14/23/19SV/RK | 上方向 | 0% |
| 光源光束 | 2350lm × 2 | 下方向 | 93% |
| | | 全方向 | 93% |

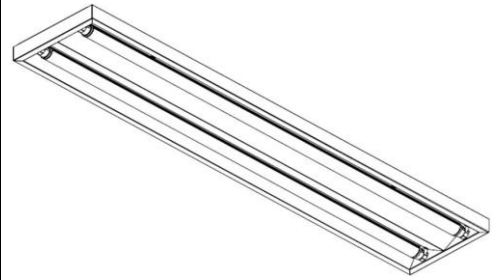

照明率表

| | | 作業面照明率(×0.01) | | | | | | | | | | | | | | | | | | | | | | | | | |
|-------------|------|---------------|-----|-----|-----|-----|----|-----|-----|-----|-----|-----|----|----|-----|----|-----|----|----|-----|----|----|----|----|----|----|----|
| 反射率 | 天井 | 80 | | | | | | | | 70 | | | | 50 | | | | 30 | | | | 0 | | | | | |
| | 壁 | 70 | 10 | 30 | 10 | 30 | 10 | 10 | 30 | 70 | 10 | 30 | 10 | 30 | 10 | 10 | 30 | 50 | 10 | 30 | 10 | 10 | 30 | 10 | 10 | 30 | 10 |
| 室 指 数 | 0.4 | 44 | 41 | 30 | 29 | 22 | 22 | 17 | 42 | 40 | 30 | 29 | 22 | 22 | 17 | 29 | 28 | 22 | 21 | 17 | 21 | 21 | 17 | 16 | | | |
| | 0.6 | 60 | 55 | 45 | 43 | 36 | 35 | 30 | 58 | 54 | 45 | 42 | 36 | 35 | 30 | 43 | 41 | 35 | 34 | 29 | 35 | 34 | 29 | 27 | | | |
| | 0.8 | 70 | 64 | 55 | 52 | 45 | 43 | 37 | 68 | 62 | 54 | 51 | 45 | 43 | 37 | 52 | 49 | 43 | 42 | 37 | 42 | 42 | 37 | 34 | | | |
| | 1 | 79 | 71 | 64 | 59 | 54 | 51 | 45 | 76 | 69 | 63 | 58 | 53 | 51 | 45 | 60 | 57 | 52 | 50 | 44 | 50 | 49 | 44 | 42 | | | |
| | 1.25 | 87 | 78 | 73 | 67 | 63 | 59 | 53 | 84 | 76 | 71 | 66 | 62 | 59 | 53 | 68 | 64 | 60 | 58 | 52 | 58 | 57 | 52 | 50 | | | |
| | 1.5 | 93 | 82 | 79 | 72 | 69 | 64 | 58 | 89 | 80 | 77 | 71 | 68 | 64 | 58 | 73 | 69 | 66 | 63 | 57 | 64 | 61 | 57 | 54 | | | |
| | 2 | 101 | 87 | 89 | 79 | 79 | 73 | 67 | 97 | 86 | 86 | 78 | 78 | 72 | 66 | 82 | 76 | 75 | 70 | 66 | 72 | 69 | 65 | 62 | | | |
| | 2.5 | 106 | 91 | 96 | 85 | 87 | 79 | 73 | 102 | 90 | 93 | 83 | 85 | 78 | 73 | 88 | 81 | 81 | 76 | 72 | 78 | 75 | 71 | 68 | | | |
| | 3 | 110 | 94 | 100 | 88 | 93 | 83 | 78 | 106 | 92 | 97 | 87 | 90 | 82 | 77 | 92 | 84 | 86 | 80 | 76 | 82 | 79 | 75 | 72 | | | |
| | 4 | 114 | 97 | 107 | 92 | 100 | 88 | 84 | 110 | 96 | 103 | 91 | 97 | 87 | 83 | 97 | 89 | 92 | 85 | 82 | 88 | 84 | 81 | 78 | | | |
| 5 | 118 | 99 | 111 | 95 | 105 | 92 | 88 | 113 | 98 | 107 | 94 | 102 | 91 | 87 | 101 | 92 | 97 | 89 | 86 | 92 | 87 | 85 | 82 | | | | |
| 7 | 121 | 102 | 116 | 99 | 112 | 96 | 93 | 117 | 100 | 112 | 98 | 108 | 95 | 92 | 105 | 95 | 102 | 93 | 91 | 96 | 91 | 89 | 86 | | | | |
| 10 | 124 | 104 | 120 | 101 | 117 | 99 | 97 | 119 | 102 | 116 | 100 | 113 | 98 | 96 | 108 | 98 | 106 | 96 | 95 | 100 | 94 | 93 | 90 | | | | |

配光曲線

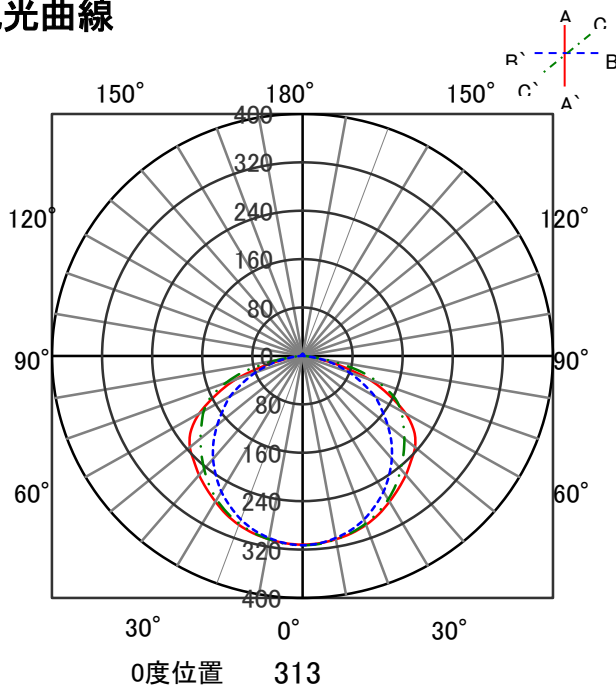

直射水平面照度

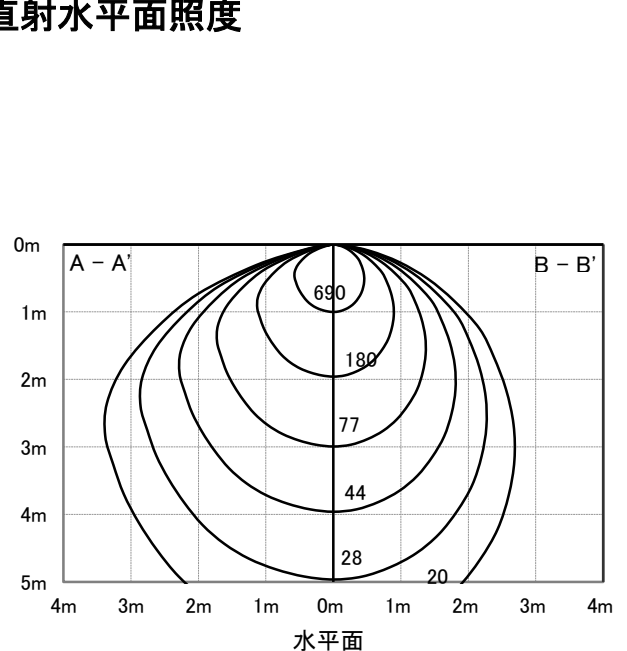

ECOHiLUX照明器具 配光データシート

意匠図

| | | | |
|------|-------------------------|------|------|
| 器具品名 | ウォールウォッシャー | 保守率 | |
| 器具品番 | IRLDFL42CLWW-K | 良 | 0.69 |
| 部品品名 | - | 中 | 0.67 |
| 部品品番 | - | 否 | 0.63 |
| | | 器具効率 | |
| 器具光束 | 3670lm | 上方向 | 3% |
| 光源 | LDG32T・WW/14/23/19SV/RK | 下方向 | 75% |
| 光源光束 | 2350lm × 2 | 全方向 | 78% |

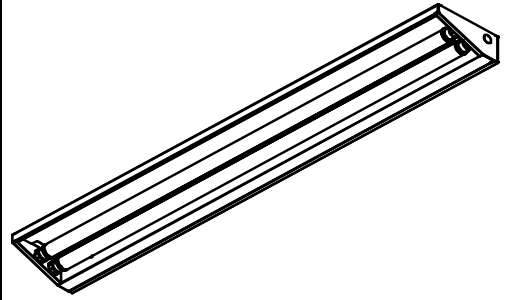

照明率表

| | | 作業面照明率(×0.01) | | | | | | | | | | | | | | | | | | | | | | |
|-------------|--------------|---------------|-----|-----|-----|----|----|-----|-----|-----|-----|-----|----|----|-----|----|-----|----|----|----|----|----|----|----|
| 反射率 | 天井 壁 床 | 80 | | | | 70 | | | | 50 | | | | 30 | | | | 0 | | | | | | |
| | | 70 | 50 | 30 | 10 | 70 | 50 | 30 | 10 | 50 | 30 | 10 | 30 | 10 | 10 | 30 | 10 | 0 | | | | | | |
| 室 指 数 | 0.4 | 43 | 40 | 29 | 28 | 22 | 21 | 17 | 41 | 39 | 29 | 28 | 21 | 21 | 16 | 27 | 27 | 21 | 20 | 16 | 20 | 20 | 16 | 14 |
| | 0.6 | 59 | 54 | 44 | 42 | 35 | 34 | 28 | 57 | 53 | 43 | 41 | 34 | 33 | 28 | 41 | 39 | 33 | 32 | 27 | 32 | 32 | 27 | 25 |
| | 0.8 | 69 | 62 | 53 | 50 | 43 | 41 | 35 | 66 | 60 | 52 | 49 | 42 | 41 | 35 | 49 | 47 | 41 | 40 | 34 | 39 | 39 | 34 | 31 |
| | 1 | 77 | 69 | 62 | 57 | 51 | 49 | 42 | 74 | 67 | 60 | 56 | 50 | 48 | 42 | 57 | 54 | 49 | 47 | 41 | 47 | 46 | 41 | 38 |
| | 1.25 | 85 | 76 | 71 | 65 | 60 | 57 | 50 | 82 | 73 | 69 | 63 | 59 | 56 | 50 | 65 | 61 | 57 | 54 | 49 | 54 | 53 | 48 | 45 |
| | 1.5 | 90 | 80 | 76 | 69 | 66 | 62 | 55 | 87 | 77 | 74 | 68 | 65 | 61 | 55 | 70 | 65 | 62 | 59 | 54 | 59 | 57 | 52 | 49 |
| | 2 | 98 | 85 | 86 | 77 | 76 | 70 | 64 | 94 | 83 | 83 | 75 | 74 | 68 | 63 | 78 | 72 | 70 | 66 | 61 | 67 | 64 | 60 | 57 |
| | 2.5 | 104 | 89 | 93 | 82 | 84 | 75 | 70 | 99 | 87 | 89 | 80 | 81 | 74 | 69 | 83 | 77 | 77 | 72 | 68 | 73 | 70 | 66 | 62 |
| | 3 | 107 | 92 | 97 | 85 | 89 | 79 | 74 | 103 | 90 | 94 | 84 | 86 | 78 | 73 | 87 | 80 | 81 | 76 | 72 | 77 | 73 | 70 | 66 |
| | 4 | 112 | 95 | 104 | 90 | 97 | 85 | 80 | 107 | 93 | 100 | 88 | 93 | 84 | 79 | 93 | 85 | 88 | 81 | 77 | 82 | 78 | 75 | 71 |
| 5 | 115 | 97 | 108 | 93 | 102 | 89 | 85 | 110 | 95 | 104 | 91 | 98 | 87 | 84 | 96 | 88 | 92 | 84 | 81 | 86 | 82 | 79 | 75 | |
| 7 | 119 | 100 | 113 | 96 | 108 | 93 | 90 | 114 | 98 | 109 | 95 | 104 | 92 | 89 | 101 | 91 | 97 | 89 | 86 | 91 | 86 | 84 | 80 | |
| 10 | 122 | 102 | 118 | 99 | 114 | 97 | 94 | 117 | 100 | 113 | 98 | 109 | 95 | 93 | 104 | 94 | 102 | 92 | 90 | 95 | 89 | 88 | 84 | |

配光曲線

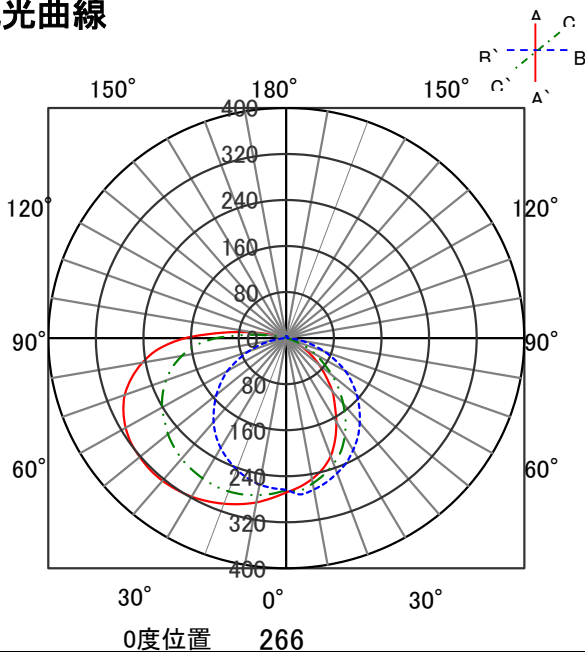

直射水平面照度

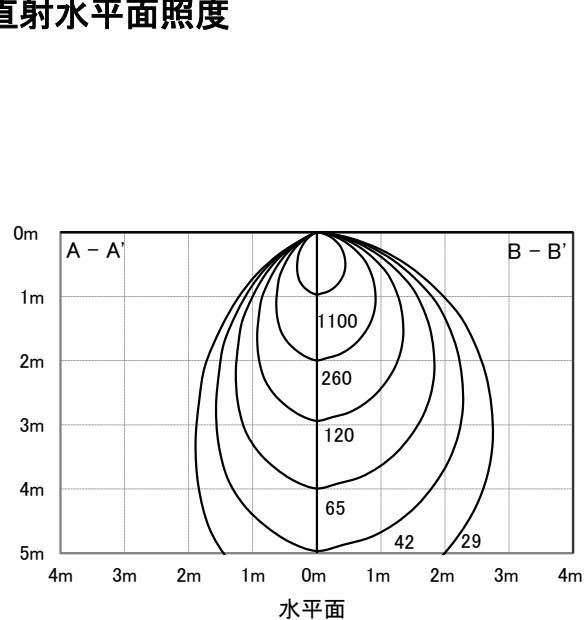

ECOHiLUX照明器具 配光データシート

意匠図

| | | | |
|------|-------------------------|------|------|
| 器具品名 | 直管用専用器具 逆富士型40形2灯 | 保守率 | |
| 器具品番 | IRLDFL42FJ-K | 良 | 0.69 |
| 部品品名 | - | 中 | 0.67 |
| 部品品番 | - | 否 | 0.63 |
| | | 器具効率 | |
| 器具光束 | 4420lm | 上方向 | 4% |
| 光源 | LDG32T-WW/14/23/19SV/RK | 下方向 | 90% |
| 光源光束 | 2350lm × 2 | 全方向 | 94% |

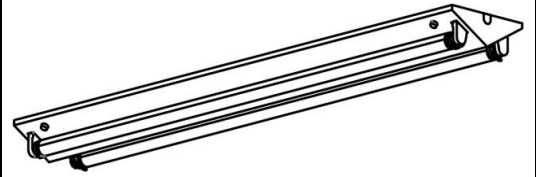

照明率表

| | | 作業面照明率(×0.01) | | | | | | | | | | | | | | | | | | | | | | | | |
|-------------|------|---------------|-----|-----|-----|----|----|-----|-----|-----|----|-----|----|----|-----|----|----|----|----|----|----|----|----|----|----|---|
| 反射率 | 天井 | 80 | | | | | | | | 70 | | | | 50 | | | | 30 | | | | 0 | | | | |
| | | 壁 | | 70 | | 50 | | 30 | | 10 | | 70 | | 50 | | 30 | | 10 | | 50 | | 30 | | 10 | | 0 |
| | 床 | 30 | 10 | 30 | 10 | 30 | 10 | 30 | 10 | 30 | 10 | 30 | 10 | 30 | 10 | 30 | 10 | 30 | 10 | 30 | 10 | 30 | 10 | 30 | 10 | 0 |
| 室 指 数 | 0.4 | 42 | 39 | 29 | 28 | 21 | 21 | 17 | 40 | 38 | 28 | 27 | 21 | 21 | 17 | 27 | 26 | 21 | 20 | 16 | 20 | 20 | 16 | 14 | | |
| | 0.6 | 57 | 53 | 43 | 41 | 35 | 34 | 28 | 55 | 51 | 42 | 40 | 34 | 33 | 28 | 41 | 39 | 33 | 33 | 28 | 32 | 32 | 28 | 25 | | |
| | 0.8 | 67 | 61 | 52 | 49 | 43 | 41 | 36 | 65 | 59 | 51 | 48 | 42 | 41 | 35 | 49 | 47 | 41 | 40 | 35 | 40 | 39 | 34 | 32 | | |
| | 1 | 75 | 67 | 61 | 57 | 51 | 49 | 43 | 72 | 66 | 59 | 55 | 50 | 48 | 42 | 56 | 54 | 49 | 47 | 42 | 47 | 46 | 41 | 39 | | |
| | 1.25 | 83 | 74 | 70 | 64 | 60 | 56 | 51 | 80 | 72 | 68 | 63 | 59 | 56 | 50 | 64 | 60 | 57 | 54 | 49 | 55 | 53 | 49 | 46 | | |
| | 1.5 | 88 | 77 | 75 | 68 | 66 | 61 | 55 | 85 | 76 | 73 | 67 | 64 | 60 | 55 | 69 | 65 | 62 | 59 | 54 | 59 | 57 | 53 | 50 | | |
| | 2 | 95 | 83 | 84 | 75 | 75 | 69 | 63 | 92 | 81 | 82 | 74 | 74 | 68 | 63 | 77 | 71 | 70 | 66 | 62 | 67 | 64 | 61 | 58 | | |
| | 2.5 | 101 | 87 | 91 | 80 | 83 | 74 | 70 | 97 | 85 | 88 | 79 | 80 | 73 | 69 | 82 | 76 | 76 | 72 | 68 | 73 | 70 | 66 | 63 | | |
| | 3 | 104 | 89 | 95 | 83 | 88 | 78 | 74 | 100 | 87 | 92 | 82 | 85 | 77 | 73 | 86 | 79 | 81 | 75 | 71 | 76 | 73 | 70 | 67 | | |
| | 4 | 108 | 92 | 101 | 88 | 95 | 83 | 79 | 104 | 90 | 98 | 86 | 92 | 82 | 79 | 91 | 83 | 86 | 80 | 77 | 82 | 78 | 75 | 72 | | |
| 5 | 111 | 94 | 105 | 90 | 100 | 87 | 83 | 107 | 92 | 101 | 89 | 96 | 85 | 82 | 94 | 86 | 90 | 83 | 80 | 85 | 81 | 79 | 75 | | | |
| 7 | 115 | 96 | 110 | 94 | 106 | 91 | 88 | 110 | 95 | 106 | 92 | 102 | 89 | 87 | 98 | 89 | 95 | 87 | 85 | 89 | 85 | 83 | 79 | | | |
| 10 | 117 | 98 | 114 | 96 | 111 | 94 | 92 | 113 | 97 | 109 | 95 | 107 | 93 | 91 | 101 | 92 | 99 | 90 | 88 | 93 | 88 | 86 | 83 | | | |

配光曲線

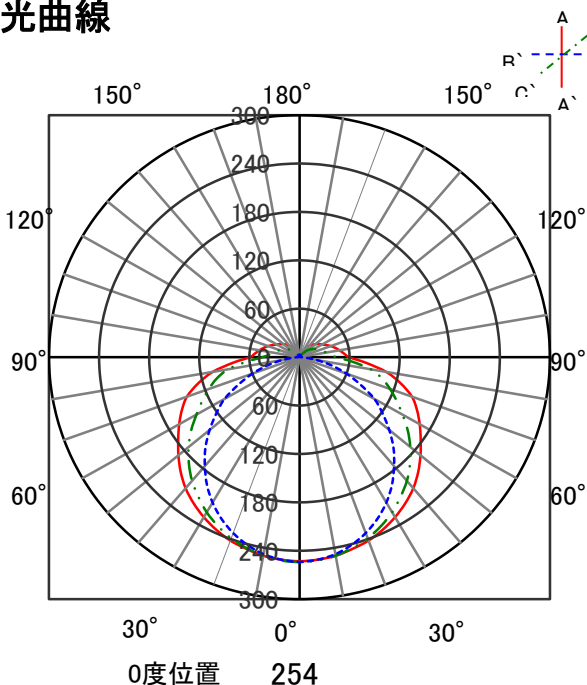

直射水平面照度

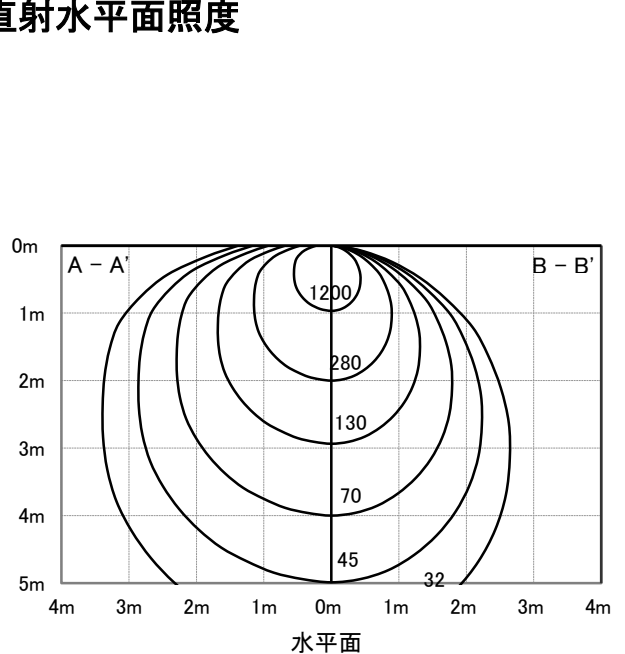

ECOHiLUX照明器具 配光データシート

意匠図

| | | | |
|------|-------------------------|------|------|
| 器具品名 | 直管用専用器具 トラフ型40形2灯 | 保守率 | |
| 器具品番 | IRLDL42TR-K | 良 | 0.69 |
| 部品品名 | - | 中 | 0.67 |
| 部品品番 | - | 否 | 0.63 |
| 器具光束 | 4320lm | 器具効率 | |
| 光源 | LDG32T・WW/14/23/19SV/RK | 上方向 | 0% |
| 光源光束 | 2350lm × 2 | 下方向 | 92% |
| | | 全方向 | 92% |

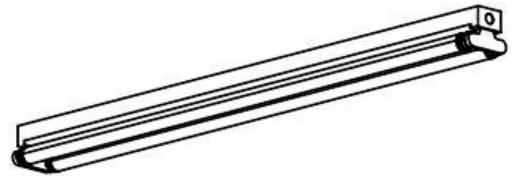

照明率表

| 作業面照明率(×0.01) | | | | | | | | | | | | | | | | | | | | | | | | | | |
|---------------|------|-----|-----|-----|-----|-----|-----|-----|-----|-----|-----|-----|-----|-----|-----|-----|-----|-----|----|-----|----|----|----|----|----|---|
| 反射率 | 天井 | 80 | | | | | | | | 70 | | | | 50 | | | | 30 | | 0 | | | | | | |
| | | 壁 | | 80 | | 50 | | 30 | | 10 | | 70 | | 50 | | 30 | | 10 | | 30 | | 10 | | 0 | | |
| | 床 | 30 | 10 | 30 | 10 | 30 | 10 | 30 | 10 | 30 | 10 | 30 | 10 | 30 | 10 | 30 | 10 | 30 | 10 | 30 | 10 | 30 | 10 | 30 | 10 | 0 |
| 室 指 数 | 0.4 | 46 | 43 | 31 | 30 | 23 | 23 | 18 | 45 | 42 | 31 | 30 | 23 | 22 | 18 | 30 | 29 | 22 | 22 | 18 | 22 | 22 | 17 | 16 | 0 | |
| | 0.6 | 63 | 58 | 47 | 45 | 37 | 36 | 30 | 61 | 57 | 46 | 44 | 37 | 36 | 30 | 45 | 43 | 36 | 35 | 30 | 36 | 35 | 30 | 28 | 0 | |
| | 0.8 | 74 | 67 | 57 | 54 | 47 | 45 | 38 | 71 | 65 | 56 | 53 | 46 | 44 | 38 | 54 | 51 | 45 | 44 | 38 | 44 | 43 | 37 | 35 | 0 | |
| | 1 | 83 | 74 | 67 | 62 | 56 | 53 | 46 | 80 | 72 | 65 | 61 | 55 | 52 | 46 | 62 | 59 | 53 | 51 | 46 | 52 | 50 | 45 | 42 | 0 | |
| | 1.25 | 92 | 81 | 76 | 70 | 65 | 61 | 55 | 88 | 79 | 74 | 69 | 64 | 61 | 54 | 71 | 67 | 62 | 60 | 54 | 60 | 58 | 53 | 51 | 0 | |
| | 1.5 | 97 | 86 | 83 | 75 | 72 | 67 | 60 | 94 | 84 | 80 | 74 | 71 | 66 | 60 | 76 | 72 | 68 | 65 | 59 | 66 | 63 | 58 | 55 | 0 | |
| | 2 | 106 | 92 | 93 | 83 | 83 | 75 | 69 | 102 | 90 | 90 | 82 | 81 | 75 | 69 | 85 | 79 | 77 | 73 | 68 | 74 | 71 | 67 | 64 | 0 | |
| | 2.5 | 111 | 96 | 100 | 88 | 91 | 82 | 76 | 107 | 94 | 97 | 87 | 88 | 81 | 75 | 91 | 84 | 84 | 79 | 74 | 81 | 77 | 73 | 70 | 0 | |
| | 3 | 115 | 99 | 105 | 92 | 96 | 86 | 81 | 111 | 97 | 102 | 91 | 94 | 85 | 80 | 96 | 88 | 89 | 83 | 79 | 85 | 81 | 78 | 74 | 0 | |
| | 4 | 120 | 102 | 112 | 97 | 104 | 92 | 87 | 116 | 101 | 108 | 95 | 101 | 91 | 86 | 101 | 93 | 96 | 89 | 85 | 91 | 87 | 84 | 80 | 0 | |
| 5 | 124 | 105 | 116 | 100 | 110 | 96 | 92 | 119 | 103 | 112 | 99 | 107 | 95 | 91 | 105 | 96 | 101 | 92 | 89 | 95 | 90 | 88 | 84 | 0 | | |
| 7 | 128 | 107 | 122 | 104 | 117 | 100 | 97 | 123 | 106 | 118 | 102 | 113 | 99 | 96 | 110 | 100 | 106 | 97 | 94 | 100 | 95 | 93 | 89 | 0 | | |
| 10 | 131 | 109 | 127 | 107 | 123 | 104 | 102 | 126 | 108 | 122 | 105 | 118 | 103 | 101 | 114 | 103 | 111 | 101 | 99 | 104 | 98 | 97 | 93 | 0 | | |

配光曲線

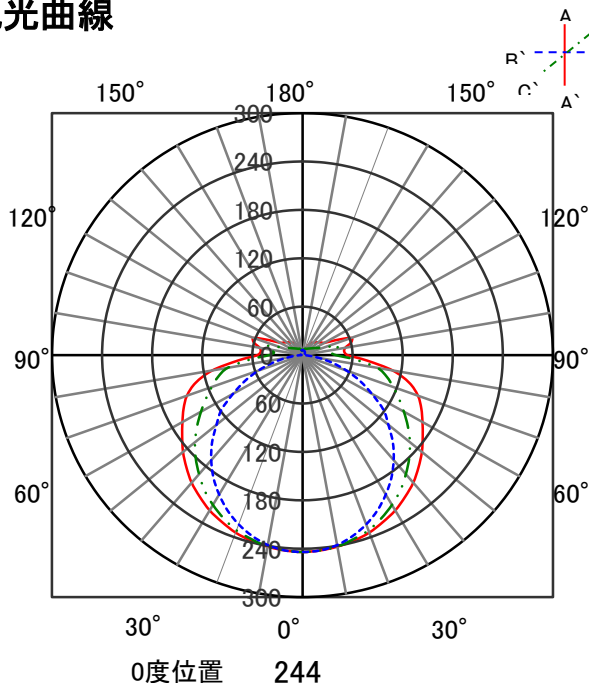

直射水平面照度

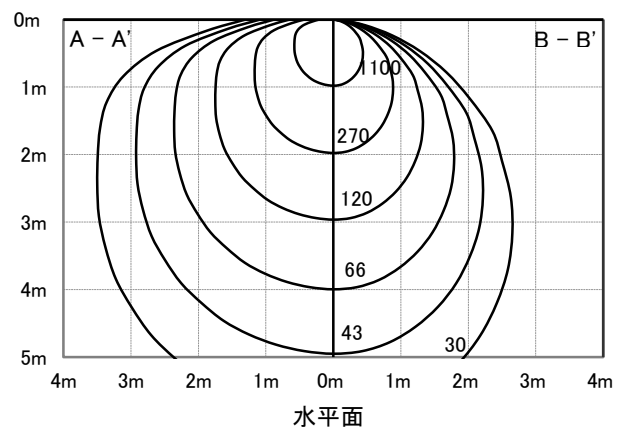

ECOHiLUX照明器具 配光データシート

意匠図

| | | | |
|------|---------------------------|------|------|
| 器具品名 | 直管型LEDランプ 専用器具 埋込下面開放型 | 保守率 | |
| 器具品番 | IRLDFL42UK-K | 良 | 0.81 |
| 部品品名 | - | 中 | 0.77 |
| 部品品番 | - | 否 | 0.67 |
| 器具光束 | 4465lm | 器具効率 | |
| 光源 | LDG32T・WW/14/23/19SV/RK | 上方向 | 0% |
| 光源光束 | 2350lm × 2 | 下方向 | 95% |
| | | 全方向 | 95% |



照明率表

| 反射率 | 天井 | 80 | | | | | | | | | | | | | | | | 70 | | | | 50 | | | | 30 | | | | 0 | | | | | | | | | | |
|-------------|------|-----|-----|-----|-----|----|----|-----|-----|-----|-----|-----|----|----|-----|----|-----|----|----|----|----|----|----|-----|-----|-----|-----|-----|----|----|-----|----|-----|----|----|----|----|----|----|----|
| | | 壁 | | 70 | | 50 | | 30 | | 10 | | 70 | | 50 | | 30 | | 10 | | 50 | | 30 | | 10 | | 30 | | 10 | | 0 | | | | | | | | | | |
| | | 床 | 30 | 10 | 30 | 10 | 30 | 10 | 30 | 10 | 30 | 10 | 30 | 10 | 30 | 10 | 30 | 10 | 30 | 10 | 30 | 10 | 30 | 10 | 30 | 10 | 30 | 10 | 30 | 10 | | | | | | | | | | |
| 室 指 数 | 0.4 | 42 | 40 | 29 | 28 | 21 | 21 | 16 | 41 | 39 | 28 | 27 | 21 | 21 | 16 | 27 | 27 | 21 | 20 | 16 | 20 | 20 | 16 | 15 | 41 | 39 | 28 | 27 | 21 | 21 | 16 | 27 | 27 | 21 | 20 | 16 | 20 | 20 | 16 | 15 |
| | 0.6 | 58 | 53 | 43 | 41 | 35 | 34 | 28 | 56 | 52 | 43 | 41 | 34 | 33 | 28 | 41 | 40 | 34 | 33 | 28 | 33 | 32 | 28 | 26 | 56 | 52 | 43 | 41 | 34 | 33 | 28 | 41 | 40 | 34 | 33 | 28 | 33 | 32 | 28 | 26 |
| | 0.8 | 68 | 62 | 53 | 50 | 43 | 41 | 35 | 66 | 60 | 52 | 49 | 43 | 41 | 35 | 50 | 47 | 42 | 40 | 35 | 41 | 40 | 35 | 33 | 66 | 60 | 52 | 49 | 43 | 41 | 35 | 50 | 47 | 42 | 40 | 35 | 41 | 40 | 35 | 33 |
| | 1 | 76 | 68 | 62 | 57 | 52 | 49 | 43 | 74 | 67 | 60 | 56 | 51 | 48 | 43 | 57 | 54 | 49 | 48 | 42 | 48 | 47 | 42 | 40 | 74 | 67 | 60 | 56 | 51 | 48 | 43 | 57 | 54 | 49 | 48 | 42 | 48 | 47 | 42 | 40 |
| | 1.25 | 84 | 75 | 70 | 65 | 61 | 57 | 51 | 81 | 73 | 69 | 64 | 60 | 56 | 50 | 66 | 62 | 58 | 55 | 50 | 56 | 54 | 50 | 47 | 81 | 73 | 69 | 64 | 60 | 56 | 50 | 66 | 62 | 58 | 55 | 50 | 56 | 54 | 50 | 47 |
| | 1.5 | 89 | 79 | 76 | 69 | 66 | 62 | 56 | 86 | 77 | 74 | 68 | 65 | 61 | 55 | 71 | 66 | 63 | 60 | 55 | 61 | 59 | 54 | 52 | 86 | 77 | 74 | 68 | 65 | 61 | 55 | 71 | 66 | 63 | 60 | 55 | 61 | 59 | 54 | 52 |
| | 2 | 97 | 85 | 86 | 76 | 76 | 70 | 64 | 94 | 83 | 83 | 75 | 75 | 69 | 64 | 79 | 73 | 72 | 68 | 63 | 69 | 66 | 62 | 60 | 94 | 83 | 83 | 75 | 75 | 69 | 64 | 79 | 73 | 72 | 68 | 63 | 69 | 66 | 62 | 60 |
| | 2.5 | 103 | 88 | 92 | 82 | 84 | 76 | 70 | 99 | 87 | 90 | 80 | 82 | 75 | 70 | 85 | 78 | 78 | 73 | 69 | 75 | 72 | 68 | 65 | 99 | 87 | 90 | 80 | 82 | 75 | 70 | 85 | 78 | 78 | 73 | 69 | 75 | 72 | 68 | 65 |
| | 3 | 106 | 91 | 97 | 85 | 89 | 79 | 75 | 102 | 89 | 94 | 84 | 87 | 79 | 74 | 88 | 81 | 83 | 77 | 73 | 79 | 75 | 72 | 69 | 102 | 89 | 94 | 84 | 87 | 79 | 74 | 88 | 81 | 83 | 77 | 73 | 79 | 75 | 72 | 69 |
| | 4 | 111 | 94 | 103 | 89 | 97 | 85 | 81 | 107 | 93 | 100 | 88 | 94 | 84 | 80 | 94 | 86 | 89 | 82 | 79 | 84 | 80 | 78 | 75 | 107 | 93 | 100 | 88 | 94 | 84 | 80 | 94 | 86 | 89 | 82 | 79 | 84 | 80 | 78 | 75 |
| 5 | 114 | 96 | 107 | 92 | 102 | 88 | 85 | 110 | 95 | 104 | 91 | 99 | 87 | 84 | 97 | 89 | 93 | 86 | 83 | 88 | 84 | 81 | 79 | 110 | 95 | 104 | 91 | 99 | 87 | 84 | 97 | 89 | 93 | 86 | 83 | 88 | 84 | 81 | 79 | |
| 7 | 118 | 99 | 113 | 96 | 108 | 93 | 90 | 113 | 97 | 109 | 94 | 105 | 92 | 89 | 102 | 92 | 98 | 90 | 88 | 93 | 88 | 86 | 83 | 113 | 97 | 109 | 94 | 105 | 92 | 89 | 102 | 92 | 98 | 90 | 88 | 93 | 88 | 86 | 83 | |
| 10 | 120 | 101 | 117 | 98 | 113 | 96 | 94 | 116 | 99 | 112 | 97 | 109 | 95 | 93 | 105 | 95 | 102 | 93 | 91 | 96 | 91 | 90 | 87 | 116 | 99 | 112 | 97 | 109 | 95 | 93 | 105 | 95 | 102 | 93 | 91 | 96 | 91 | 90 | 87 | |

配光曲線

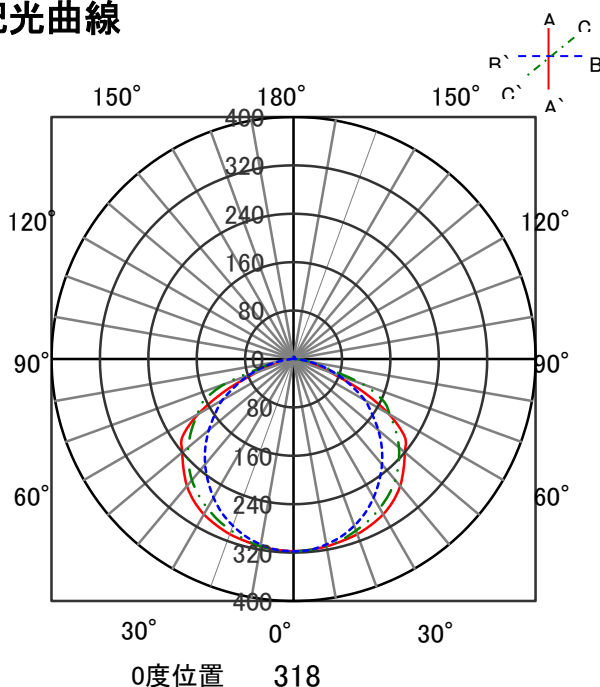

直射水平面照度

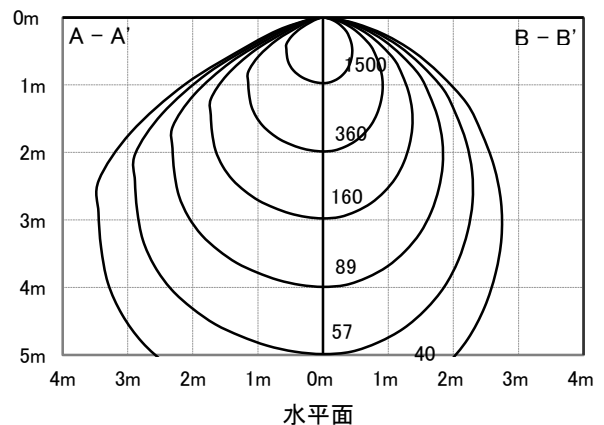

ECOHiLUX照明器具 配光データシート

意匠図

| | | | |
|------|---------------------------|------|------|
| 器具品名 | 直管型LEDランプ 専用器具 埋込下面開放型 | 保守率 | |
| 器具品番 | IRLDLFL44UK-K | 良 | 0.81 |
| 部品品名 | - | 中 | 0.77 |
| 部品品番 | - | 否 | 0.67 |
| 器具光束 | 8742lm | 器具効率 | |
| 光源 | LDG32T・WW/14/23/19SV/RK | 上方向 | 0% |
| 光源光束 | 2350lm × 4 | 下方向 | 93% |
| | | 全方向 | 93% |

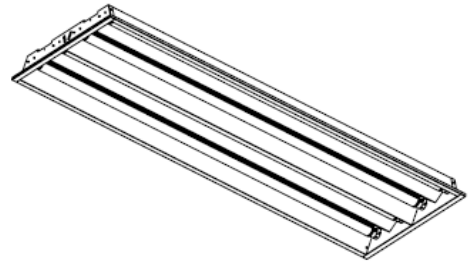

照明率表

| | | 作業面照明率(×0.01) | | | | | | | | | | | | | | | | | | | | | | | | |
|-------------|------|---------------|-----|-----|-----|-----|-----|-----|-----|-----|-----|-----|-----|----|-----|-----|-----|----|----|-----|----|----|----|----|----|---|
| 反射率 | 天井 | 80 | | | | | | | | 70 | | | | 50 | | | | 30 | | 0 | | | | | | |
| | | 壁 | | 70 | | 50 | | 30 | | 10 | | 70 | | 50 | | 30 | | 10 | | 30 | | 10 | | 0 | | |
| | 床 | 30 | 10 | 30 | 10 | 30 | 10 | 10 | 30 | 10 | 30 | 10 | 30 | 10 | 10 | 30 | 10 | 30 | 10 | 10 | 30 | 10 | 10 | 30 | 10 | 0 |
| 室 指 数 | 0.4 | 46 | 43 | 32 | 31 | 25 | 24 | 20 | 45 | 42 | 32 | 31 | 25 | 24 | 20 | 31 | 30 | 24 | 24 | 20 | 24 | 24 | 20 | 18 | | |
| | 0.6 | 64 | 59 | 50 | 47 | 41 | 40 | 35 | 62 | 58 | 49 | 47 | 41 | 39 | 34 | 47 | 45 | 40 | 39 | 34 | 39 | 38 | 34 | 32 | | |
| | 0.8 | 75 | 68 | 60 | 57 | 51 | 49 | 43 | 72 | 66 | 59 | 56 | 50 | 49 | 43 | 57 | 54 | 49 | 48 | 43 | 48 | 47 | 43 | 41 | | |
| | 1 | 84 | 75 | 70 | 65 | 61 | 58 | 52 | 81 | 74 | 69 | 64 | 60 | 57 | 52 | 66 | 63 | 58 | 56 | 52 | 57 | 56 | 51 | 49 | | |
| | 1.25 | 92 | 82 | 80 | 73 | 71 | 66 | 61 | 89 | 80 | 78 | 72 | 70 | 66 | 61 | 75 | 70 | 68 | 65 | 60 | 66 | 64 | 60 | 58 | | |
| | 1.5 | 98 | 86 | 86 | 78 | 77 | 71 | 66 | 94 | 84 | 84 | 77 | 76 | 71 | 66 | 80 | 75 | 73 | 70 | 65 | 71 | 69 | 65 | 62 | | |
| | 2 | 105 | 91 | 95 | 85 | 87 | 79 | 74 | 102 | 90 | 92 | 84 | 85 | 78 | 74 | 88 | 82 | 82 | 77 | 73 | 79 | 76 | 72 | 70 | | |
| | 2.5 | 110 | 95 | 101 | 89 | 94 | 85 | 80 | 106 | 93 | 98 | 88 | 92 | 84 | 80 | 93 | 86 | 88 | 82 | 79 | 84 | 81 | 78 | 76 | | |
| | 3 | 113 | 97 | 105 | 92 | 99 | 88 | 84 | 109 | 96 | 102 | 91 | 96 | 87 | 84 | 97 | 89 | 92 | 86 | 83 | 88 | 84 | 81 | 79 | | |
| | 4 | 117 | 100 | 111 | 96 | 105 | 92 | 89 | 113 | 98 | 107 | 95 | 102 | 92 | 89 | 101 | 93 | 97 | 90 | 87 | 93 | 88 | 86 | 83 | | |
| 5 | 120 | 101 | 114 | 98 | 110 | 95 | 93 | 116 | 100 | 111 | 97 | 106 | 94 | 92 | 104 | 95 | 101 | 93 | 90 | 96 | 91 | 89 | 86 | | | |
| 7 | 123 | 103 | 119 | 101 | 115 | 99 | 96 | 118 | 102 | 115 | 100 | 111 | 98 | 96 | 107 | 97 | 105 | 96 | 94 | 99 | 94 | 92 | 90 | | | |
| 10 | 125 | 105 | 122 | 103 | 119 | 101 | 100 | 121 | 103 | 118 | 102 | 115 | 100 | 99 | 110 | 99 | 108 | 98 | 97 | 102 | 96 | 95 | 92 | | | |

配光曲線

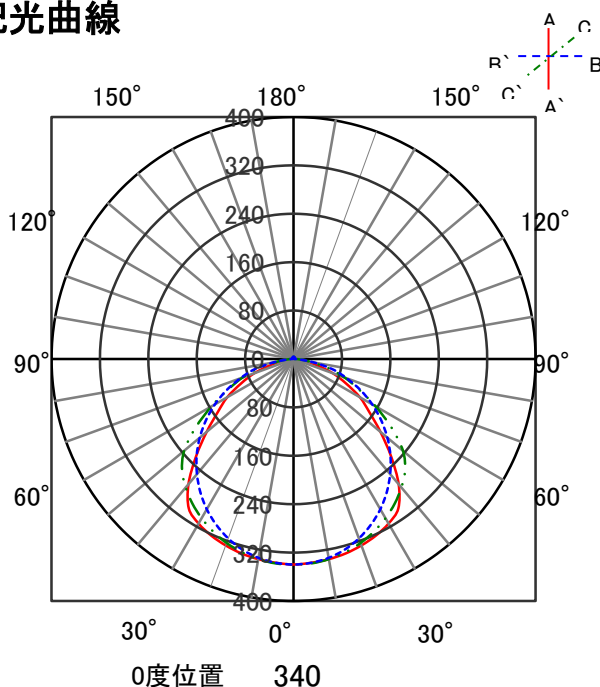

直射水平面照度

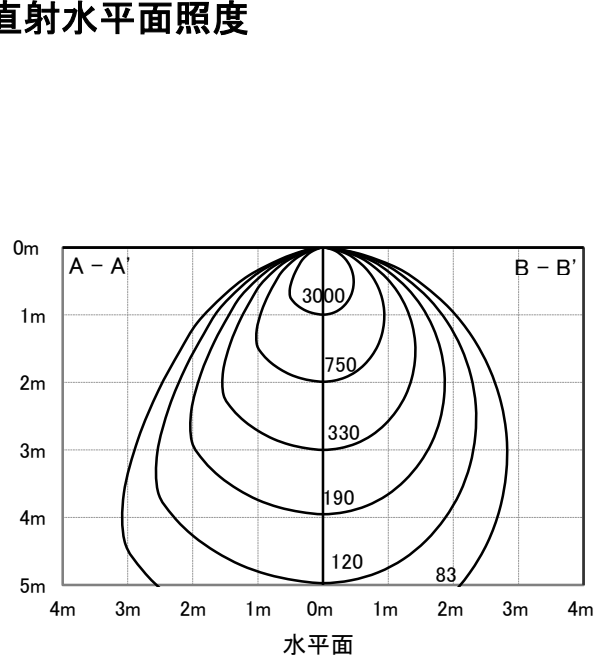

ECOHiLUX照明器具 配光データシート

意匠図

| | | | |
|------|---------------------------|------|------|
| 器具品名 | 直管型LEDランプ 専用器具 埋込下面開放型 | 保守率 | |
| 器具品番 | IRLDL44UK-LVK | 良 | 0.81 |
| 部品品名 | - | 中 | 0.77 |
| 部品品番 | - | 否 | 0.67 |
| 器具光束 | 7896lm | 器具効率 | |
| 光源 | LDG32T・WW/14/23/19SV/RK | 上方向 | 0% |
| 光源光束 | 2350lm × 4 | 下方向 | 84% |
| | | 全方向 | 84% |

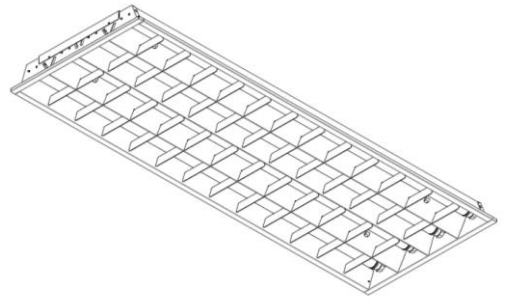

照明率表

| | | 作業面照明率(×0.01) | | | | | | | | | | | | | | | | | | | | | | |
|-------------|--------------|---------------|-----|-----|-----|-----|----|-----|-----|-----|-----|-----|-----|----|-----|-----|-----|----|----|-----|----|----|----|----|
| 反射率 | 天井 壁 床 | 80 | | | | 70 | | | | 50 | | | | 30 | | | | 0 | | | | | | |
| | | 70 | 50 | 30 | 10 | 70 | 50 | 30 | 10 | 50 | 30 | 10 | 30 | 10 | 10 | 30 | 10 | 0 | 0 | | | | | |
| 室 指 数 | 0.4 | 46 | 44 | 33 | 32 | 26 | 25 | 21 | 45 | 43 | 33 | 32 | 26 | 25 | 21 | 32 | 31 | 25 | 25 | 21 | 25 | 24 | 21 | 19 |
| | 0.6 | 65 | 60 | 51 | 48 | 42 | 41 | 36 | 63 | 58 | 50 | 48 | 42 | 41 | 36 | 48 | 46 | 41 | 40 | 35 | 40 | 40 | 35 | 33 |
| | 0.8 | 75 | 68 | 61 | 57 | 52 | 50 | 44 | 73 | 67 | 60 | 57 | 51 | 49 | 44 | 58 | 55 | 50 | 49 | 44 | 49 | 48 | 44 | 42 |
| | 1 | 84 | 76 | 71 | 65 | 61 | 58 | 53 | 82 | 74 | 69 | 65 | 61 | 58 | 53 | 67 | 63 | 59 | 57 | 52 | 58 | 56 | 52 | 50 |
| | 1.25 | 93 | 82 | 80 | 73 | 71 | 67 | 62 | 90 | 81 | 78 | 73 | 70 | 66 | 61 | 75 | 71 | 68 | 65 | 61 | 66 | 64 | 60 | 58 |
| | 1.5 | 98 | 86 | 86 | 78 | 77 | 72 | 67 | 95 | 84 | 84 | 77 | 76 | 71 | 66 | 80 | 75 | 73 | 70 | 66 | 71 | 69 | 65 | 63 |
| | 2 | 105 | 91 | 95 | 85 | 87 | 79 | 75 | 102 | 90 | 92 | 84 | 85 | 79 | 74 | 88 | 82 | 82 | 77 | 73 | 79 | 76 | 73 | 70 |
| | 2.5 | 110 | 95 | 101 | 89 | 94 | 85 | 81 | 106 | 93 | 98 | 88 | 92 | 84 | 80 | 93 | 86 | 88 | 82 | 79 | 84 | 81 | 78 | 76 |
| | 3 | 113 | 97 | 105 | 92 | 99 | 88 | 84 | 109 | 96 | 102 | 91 | 96 | 87 | 84 | 97 | 89 | 92 | 86 | 82 | 88 | 84 | 81 | 79 |
| | 4 | 117 | 100 | 111 | 96 | 105 | 92 | 89 | 113 | 98 | 107 | 95 | 102 | 91 | 88 | 101 | 92 | 97 | 90 | 87 | 92 | 88 | 86 | 83 |
| 5 | 120 | 101 | 114 | 98 | 109 | 95 | 92 | 116 | 100 | 111 | 97 | 106 | 94 | 92 | 104 | 95 | 101 | 92 | 90 | 95 | 91 | 89 | 86 | |
| 7 | 123 | 103 | 119 | 101 | 115 | 98 | 96 | 118 | 102 | 115 | 100 | 111 | 97 | 95 | 107 | 97 | 105 | 96 | 94 | 99 | 94 | 92 | 89 | |
| 10 | 125 | 105 | 122 | 103 | 119 | 101 | 99 | 120 | 103 | 118 | 102 | 115 | 100 | 98 | 110 | 99 | 108 | 98 | 97 | 102 | 96 | 95 | 92 | |

配光曲線

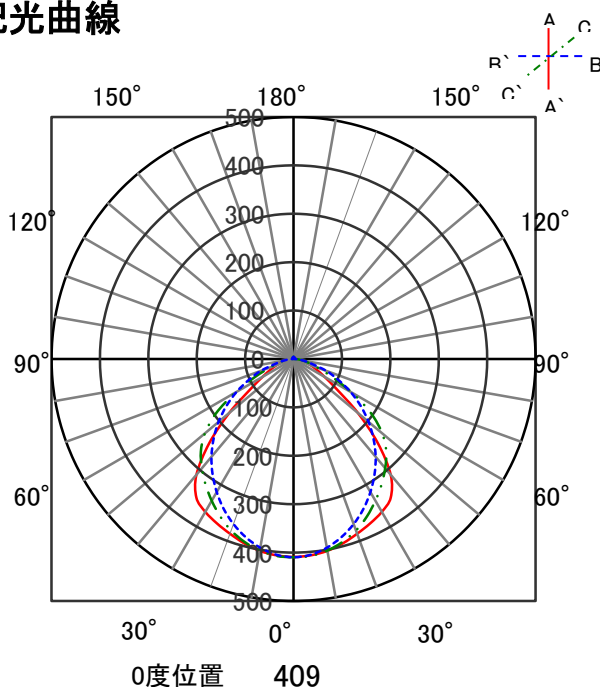

直射水平面照度

