

ECOHiLUX照明器具 配光データシート

意匠図

器具品名	スポットライト	保守率	
器具品番	SP10L27-60UCW	良	0.78
部品品名	-	中	0.74
部品品番	-	否	0.70
器具光束	900lm	器具効率	
光源	-	上方向	0%
光源光束	一体型器具のため、器具光束表示	下方向	100%
		全方向	100%

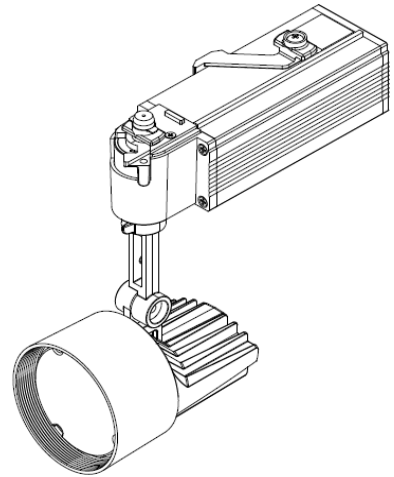

照明率表

		作業面照明率(×0.01)																						
反射率	天井 壁 床	80				70				50				30			0							
		70	50	30	10	70	50	30	10	50	30	10	30	10	0									
室 指 数	0.4	59	56	48	46	41	41	37	58	55	47	46	41	40	37	47	45	41	40	37	41	40	37	35
	0.6	81	74	70	66	63	61	57	79	73	69	66	63	61	57	68	65	62	60	57	61	60	57	56
	0.8	88	80	77	72	70	67	63	86	79	76	72	69	66	63	74	71	68	66	62	67	65	62	61
	1	96	86	86	79	78	74	71	94	85	84	79	78	74	70	82	77	76	73	70	75	73	70	68
	1.25	104	92	94	86	87	82	79	101	91	93	86	86	82	78	90	84	84	81	78	82	80	77	76
	1.5	107	94	98	89	91	85	81	104	93	96	88	90	84	81	92	87	87	83	80	85	82	80	78
	2	113	98	105	93	98	90	87	109	97	102	93	97	89	86	98	91	93	88	85	90	87	85	83
	2.5	117	101	110	97	104	94	92	113	99	107	96	102	93	91	102	94	98	92	90	95	91	89	87
	3	119	102	113	99	108	96	94	115	101	110	98	105	95	93	104	96	101	94	92	97	93	91	89
	4	122	104	117	101	113	99	97	118	103	114	100	110	98	97	108	98	105	97	95	100	95	94	92
5	124	105	120	103	117	101	100	120	104	116	102	113	100	99	110	100	107	99	98	102	97	96	94	
7	126	106	123	105	121	104	103	122	105	119	104	117	103	102	112	102	110	101	100	105	99	98	96	
10	128	107	126	106	124	105	105	124	106	122	105	120	104	104	114	103	113	102	102	106	101	100	97	

配光曲線

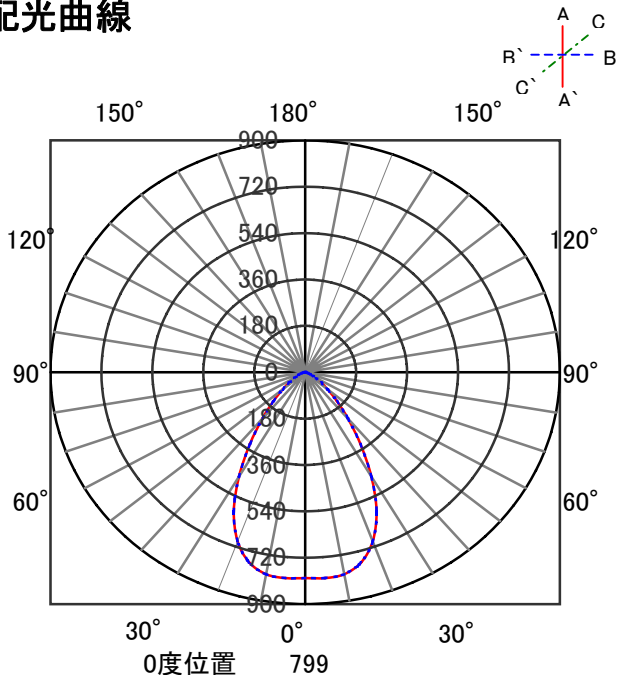

直射水平面照度

