

ECOHiLUX照明器具 配光データシート

意匠図

器具品名	スポットライト	保守率	
器具品番	SP4W-25MUB	良	0.78
部品品名	-	中	0.74
部品品番	-	否	0.70
器具光束	468lm	器具効率	
光源	-	上方向	0%
光源光束	一体型器具のため、器具光束表示	下方向	100%
		全方向	100%

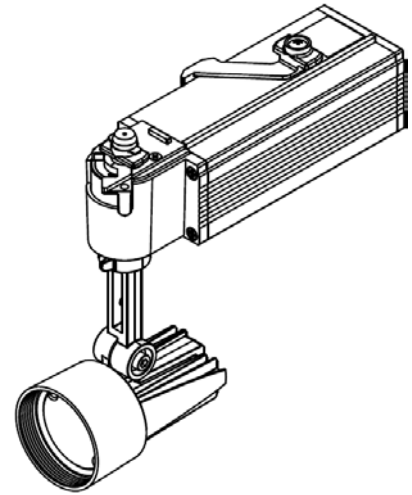

照明率表

		作業面照明率(×0.01)																						
反射率	天井 壁 床	80				70				50				30				0						
		70	50	30	10	70	50	30	10	50	30	10	30	10	10	30	10	0	0					
室 指 数	0.4	60	56	49	47	43	42	38	58	55	48	47	42	42	38	47	46	42	41	38	42	41	38	37
	0.6	77	71	66	63	60	58	54	76	70	66	63	59	58	54	64	62	59	57	54	58	57	54	53
	0.8	87	79	77	72	70	67	63	85	78	76	71	69	67	63	74	70	68	66	63	67	66	63	61
	1	94	84	84	78	77	73	69	92	83	82	77	76	73	69	80	76	75	72	69	73	71	69	67
	1.25	100	89	90	83	84	79	75	97	87	89	82	83	78	75	86	81	81	77	74	79	76	74	72
	1.5	104	91	95	86	88	82	79	101	90	93	85	87	82	78	90	84	85	81	78	82	80	77	76
	2	109	95	101	90	95	87	84	106	93	99	90	93	86	84	95	88	90	85	83	87	84	82	80
	2.5	112	97	106	93	100	90	88	109	96	103	92	98	90	87	98	91	94	88	86	91	87	85	83
	3	115	98	109	95	104	93	90	111	97	106	94	101	92	90	101	93	97	90	89	93	89	88	85
	4	118	100	113	98	109	96	94	114	99	110	97	106	95	93	104	95	101	93	92	97	92	91	88
5	120	101	116	100	113	98	96	116	100	112	99	109	97	96	106	97	104	95	94	99	94	93	90	
7	122	103	119	101	117	100	99	118	102	116	100	113	99	98	109	98	107	98	97	101	96	95	93	
10	124	104	122	103	120	102	102	120	103	118	102	116	101	101	111	100	109	99	99	103	98	97	95	

配光曲線

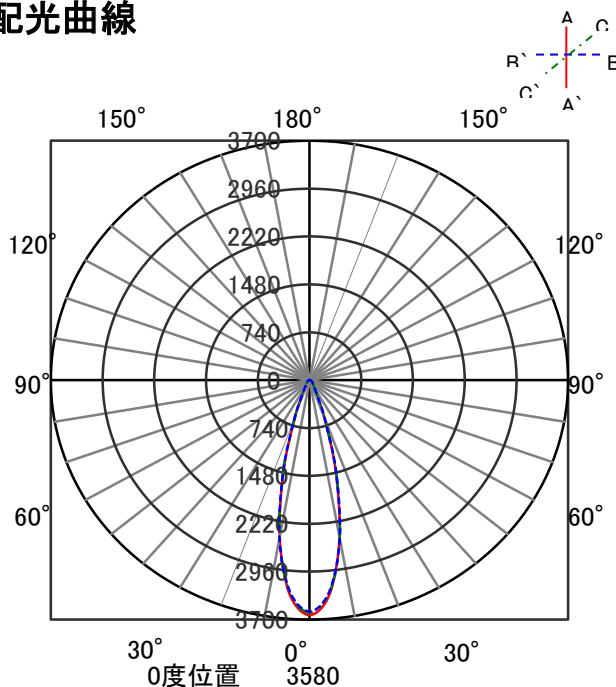

直射水平面照度

