

ECOHiLUX照明器具 配光データシート

意匠図

器具品名	直管用専用器具 直付下面開放型16形1灯	保守率	
器具品番	IRLDL161CL-K	良	0.69
部品品名	-	中	0.67
部品品番	-	否	0.63
器具光束	810lm	器具効率	
光源	LDG16T・WW/6/9/19SV/RK/C	上方向	0%
光源光束	900lm	下方向	90%
		全方向	90%

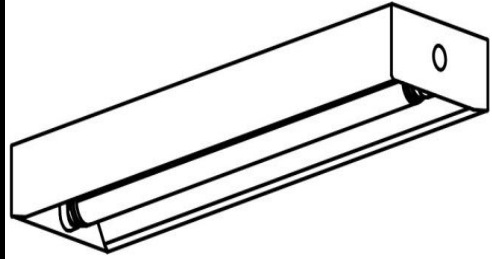

照明率表

		作業面照明率(×0.01)																						
反射率	天井	80								70								50				30		0
	壁	70	50	30	10	70	50	30	10	70	50	30	10	50	30	10	30	10	30	10	0			
室	床	30	10	30	10	30	10	10	30	10	30	10	30	10	10	30	10	30	10	10	0			
	0.4	41	39	28	27	21	21	16	40	38	28	27	21	20	16	27	26	20	20	16	20	15		
	0.6	57	52	43	40	34	33	28	55	51	42	40	34	33	28	40	39	33	32	28	32	26		
	0.8	66	60	52	48	42	41	35	64	59	51	48	42	40	35	49	46	41	40	34	40	32		
	1	74	67	60	56	50	48	42	72	65	59	55	50	47	42	56	53	48	47	42	47	39		
	1.25	82	73	69	63	59	56	50	79	71	67	62	58	55	50	64	60	56	54	49	55	46		
	1.5	87	77	74	68	65	60	55	84	75	72	67	64	60	54	69	65	62	59	54	60	51		
	2	95	82	83	74	75	68	63	91	81	81	73	73	67	62	77	71	70	66	62	67	58		
	2.5	100	86	90	79	82	74	69	96	84	87	78	80	73	68	82	76	76	72	68	73	64		
	3	103	88	94	83	87	78	73	99	87	91	81	85	77	73	86	79	81	75	71	77	68		
	4	108	92	100	87	94	83	79	104	90	97	86	91	82	78	91	83	87	80	77	82	73		
	5	111	94	105	90	99	86	83	106	92	101	89	96	85	82	95	86	91	83	81	86	77		
	7	114	96	109	93	105	90	88	110	94	106	92	102	89	87	99	90	96	87	85	90	81		
	10	117	98	113	96	110	93	92	112	96	109	94	106	92	91	102	92	100	90	89	94	84		

配光曲線

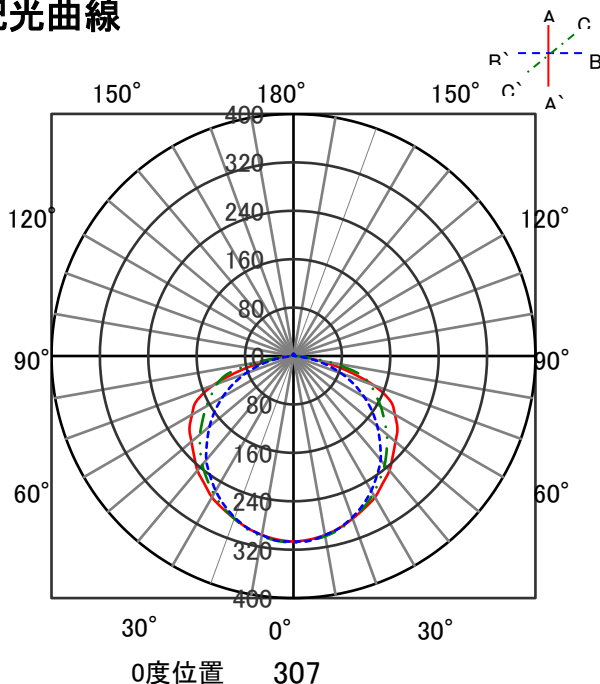

直射水平面照度

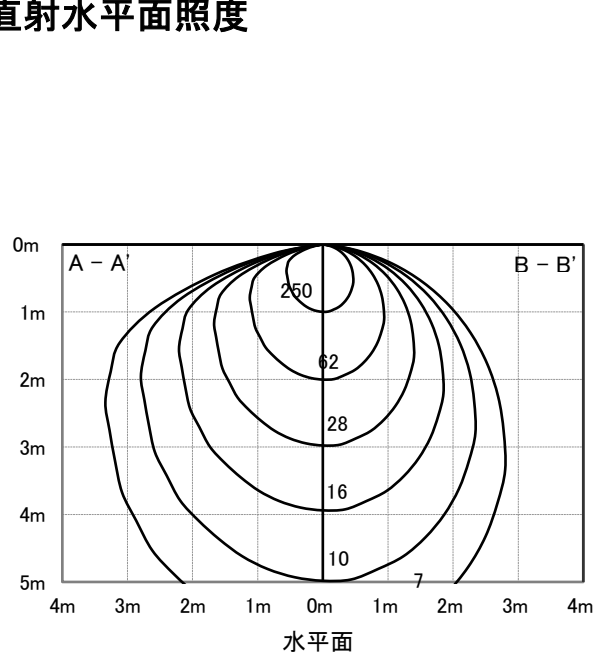

ECOHiLUX照明器具 配光データシート

意匠図

器具品名	直管用専用器具 逆富士型16形1灯	保守率	
器具品番	IRLDL161FJ-K	良	0.69
部品品名	-	中	0.67
部品品番	-	否	0.63
器具光束	830lm	器具効率	
光源	LDG16T-WW/6/9/19SV/RK/C	上方向	8%
光源光束	900lm	下方向	84%
		全方向	92%

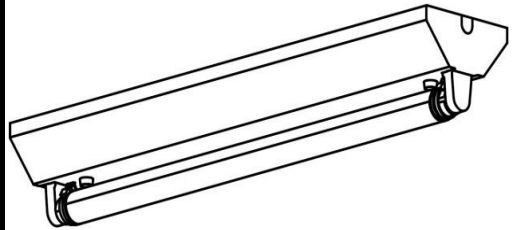

照明率表

		作業面照明率(×0.01)																						
反射率	天井	80								70								50				30		0
		壁		70		50		30		10		70		50		30		10		50	30	10	0	
	床	30	10	30	10	30	10	10	30	10	30	10	30	10	10	30	10	30	10	10	30	10	10	0
室 指 数	0.4	43	41	29	28	22	21	17	42	39	29	28	21	21	17	27	26	21	20	16	20	20	16	14
	0.6	59	55	44	42	35	34	29	57	53	43	41	35	34	28	41	39	33	32	28	32	31	27	24
	0.8	69	63	54	50	44	42	36	66	61	52	49	43	41	35	49	47	41	40	35	39	38	34	31
	1	78	70	62	58	52	50	43	74	67	61	57	51	49	43	57	54	49	47	42	46	45	40	37
	1.25	86	76	71	65	61	57	51	82	74	69	64	60	56	50	65	61	57	54	49	54	52	48	44
	1.5	91	80	77	70	67	62	56	87	78	75	68	65	61	55	70	65	62	59	54	59	57	52	48
	2	99	86	87	77	77	70	64	94	83	83	76	75	69	64	77	72	70	66	62	66	64	60	56
	2.5	104	90	93	83	85	76	71	99	87	90	81	82	75	70	83	77	77	72	68	72	69	65	61
	3	108	92	98	86	90	80	75	103	90	94	84	87	79	74	87	80	81	76	72	76	73	69	65
	4	113	96	105	90	97	86	81	107	93	100	88	94	84	80	92	84	87	81	77	81	78	75	70
5	116	98	109	93	103	89	85	110	95	104	91	99	88	84	96	87	91	84	81	85	81	78	73	
7	120	100	114	97	109	94	91	114	98	109	95	105	92	89	100	91	97	88	86	89	85	83	78	
10	122	102	118	100	115	97	95	117	100	113	98	110	95	93	104	94	101	92	90	93	88	86	81	

配光曲線

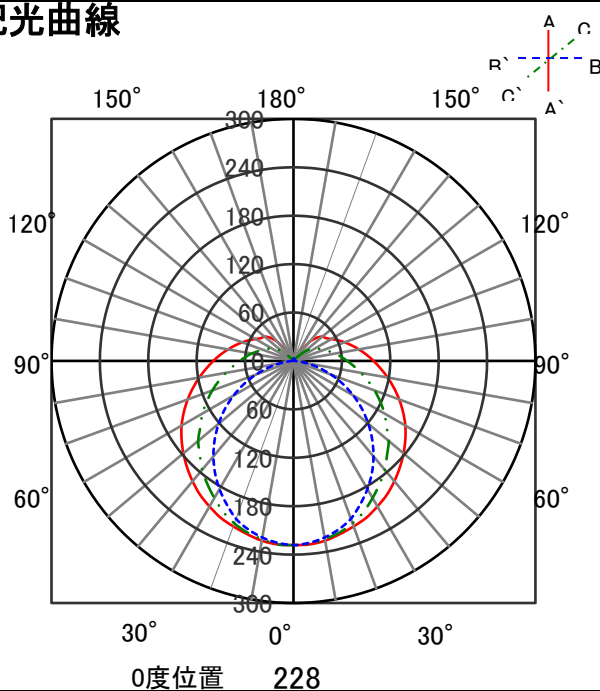

直射水平面照度

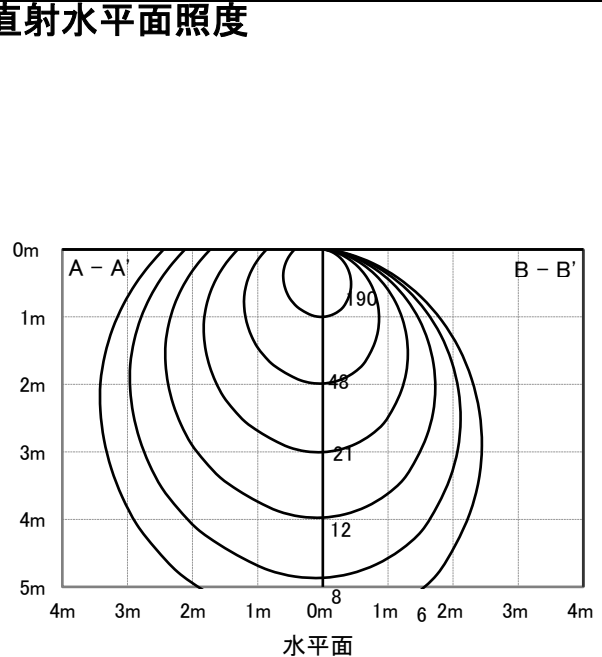

ECOHiLUX照明器具 配光データシート

意匠図

器具品名	直管用専用器具 トラフ型16形1灯	保守率	
器具品番	IRLDL161TR-K	良	0.69
部品品名	-	中	0.67
部品品番	-	否	0.63
		器具効率	
器具光束	830lm	上方向	8%
光源	LDG16T・WW/6/9/19SV/RK/C	下方向	84%
光源光束	900lm	全方向	92%

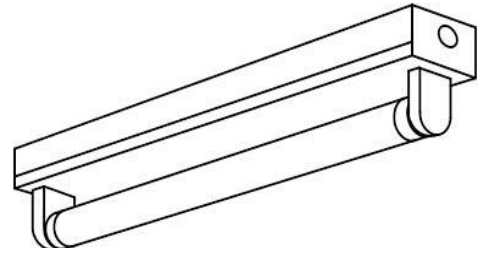

照明率表

		作業面照明率(×0.01)																						
反射率	天井	80								70				50				30		0				
	壁	70	10	30	10	30	10	10	30	70	50	30	10	50	30	10	10	30	10	10	0			
	床	30	10	30	10	30	10	10	30	10	30	10	30	10	10	30	10	30	10	10	30	10	10	0
室 指 数	0.4	42	40	29	28	21	21	16	41	38	28	27	21	21	16	27	26	20	20	16	19	19	15	13
	0.6	58	54	43	41	34	33	28	56	52	42	40	34	33	27	40	38	32	32	27	31	30	26	23
	0.8	68	62	53	49	43	41	35	65	60	51	48	42	40	34	48	46	40	39	34	38	37	33	30
	1	76	68	61	57	51	48	42	73	66	59	55	50	48	42	56	53	48	46	40	45	44	39	36
	1.25	84	75	70	64	60	56	50	81	72	68	63	58	55	49	63	60	55	53	48	53	51	47	43
	1.5	90	79	76	69	66	61	55	85	76	73	67	64	60	54	68	64	61	58	53	57	55	51	47
	2	97	85	85	76	76	69	63	93	82	82	74	73	68	62	76	71	69	65	60	65	63	58	54
	2.5	103	89	92	81	83	75	70	98	86	88	79	80	73	68	82	76	75	71	66	71	68	64	60
	3	106	91	97	85	88	79	74	101	89	93	83	85	77	73	85	79	80	74	70	75	71	68	63
	4	111	94	103	89	96	84	80	106	92	99	87	92	83	79	91	83	86	79	76	80	76	73	68
5	114	97	107	92	101	88	84	109	94	103	90	97	86	83	94	86	90	83	80	84	79	77	72	
7	118	99	112	96	108	92	89	112	97	108	93	103	90	88	99	89	95	87	84	88	83	81	76	
10	121	101	117	98	113	96	94	115	99	111	96	108	94	92	102	92	99	90	88	92	87	85	80	

配光曲線

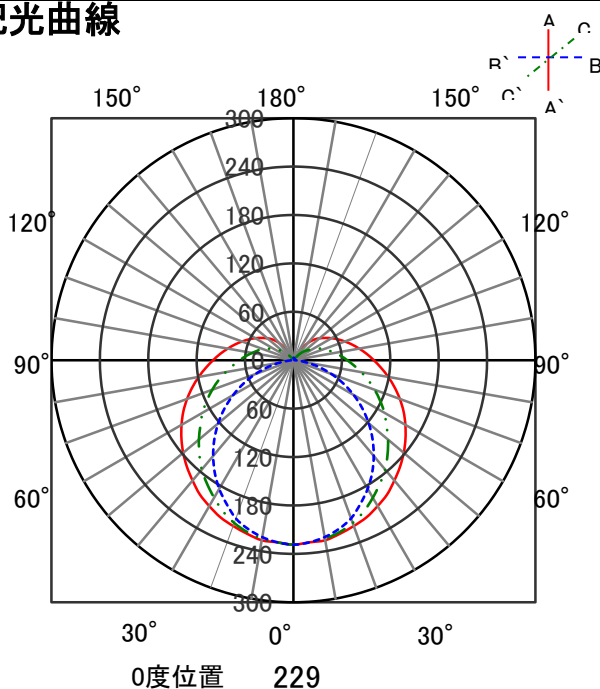

直射水平面照度

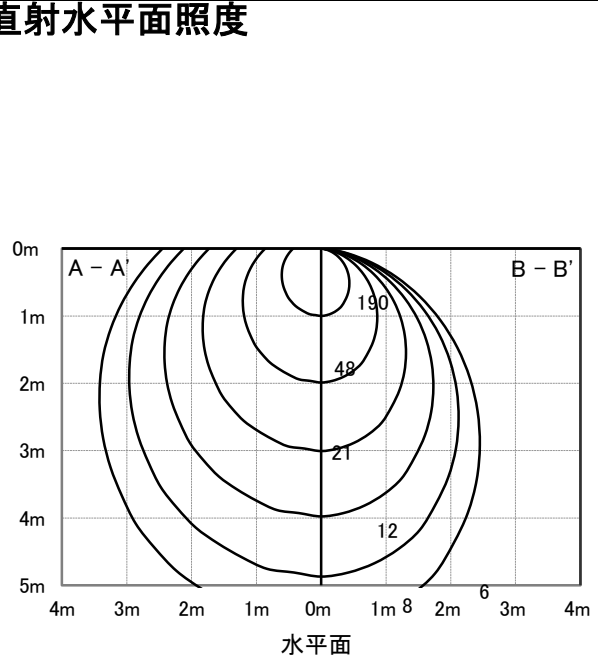

ECOHiLUX照明器具 配光データシート

意匠図

器具品名	直管用専用器具 直付下面開放型16形1灯	保守率	
器具品番	IRLDL161UK-K	良	0.69
部品品名	-	中	0.67
部品品番	-	否	0.63
器具光束	840lm	器具効率	
光源	LDG16T-WW/6/9/19SV/RK/C	上方向	0%
光源光束	900lm	下方向	93%
		全方向	93%

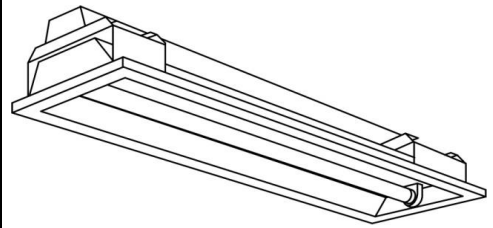

照明率表

		作業面照明率(×0.01)																													
反射率	天井	80						70						50						30						0					
		壁		70		50		30		10		70		50		30		10		50		30		10		30		10		0	
	床	30	10	30	10	30	10	30	10	30	10	30	10	30	10	30	10	30	10	30	10	30	10	30	10	30	10	30	10	0	
室 指 数	0.4	39	37	27	26	20	19	15	38	36	26	25	20	19	15	25	25	19	19	15	19	19	15	19	19	15	14				
	0.6	54	50	40	38	32	31	26	52	48	40	38	32	31	26	38	37	31	31	26	31	30	26	24							
	0.8	63	57	49	46	40	39	33	61	56	48	45	40	38	33	46	44	39	38	33	38	37	32	30							
	1	71	64	57	53	48	46	40	68	62	56	52	47	45	40	53	51	46	44	39	45	44	39	37							
	1.25	78	69	66	60	56	53	47	75	68	64	59	55	52	47	61	57	54	51	47	52	51	46	44							
	1.5	83	73	71	64	62	57	52	80	72	69	63	61	57	52	66	62	59	56	51	57	55	51	48							
	2	90	78	80	71	71	65	60	87	77	77	70	70	64	59	73	68	67	63	59	64	62	58	56							
	2.5	95	82	86	76	78	70	66	92	81	83	75	76	70	65	79	73	73	68	64	70	67	64	61							
	3	98	84	90	79	83	74	70	95	83	87	78	81	73	69	82	76	77	72	68	73	70	67	65							
	4	103	87	96	83	90	79	75	99	86	93	82	87	78	75	87	80	83	76	74	79	75	72	70							
5	106	89	100	86	95	82	79	102	88	96	85	92	81	78	90	82	87	80	77	82	78	76	73								
7	109	92	104	89	100	86	84	105	90	101	88	97	85	83	94	86	91	83	81	86	82	80	77								
10	112	93	108	91	105	89	87	107	92	104	90	102	88	87	97	88	95	86	85	90	85	83	81								

配光曲線

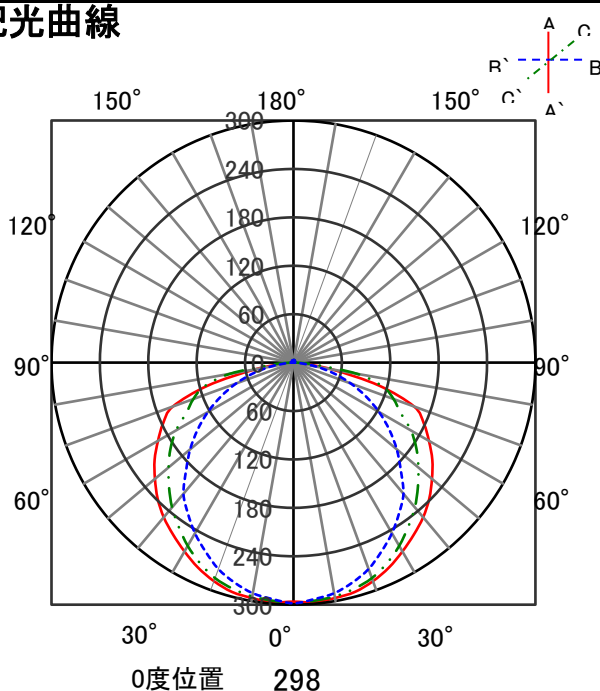

直射水平面照度

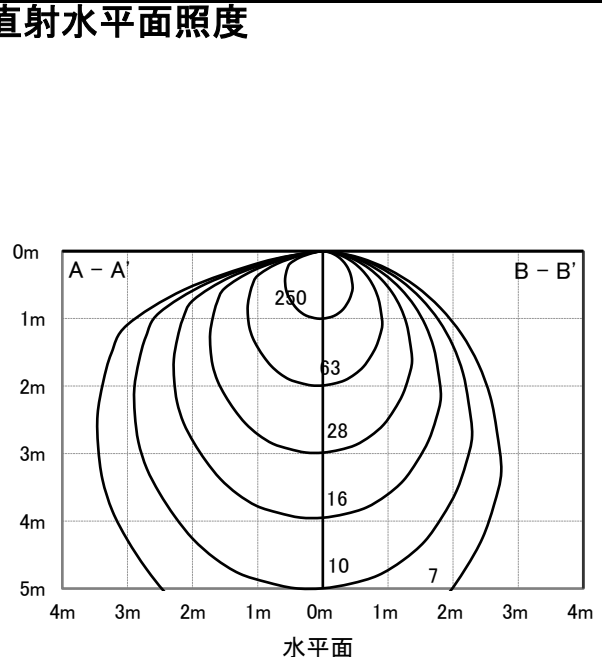

ECOHiLUX照明器具 配光データシート

意匠図

器具品名	直管用専用器具 直付下面開放型16形2灯	保守率	
器具品番	IRLDL162CL-K	良	0.81
部品品名	-	中	0.77
部品品番	-	否	0.67
器具光束	850lm	器具効率	
光源	LDG16T・WW/6/9/19SV/RK/C	上方向	0%
光源光束	900lm × 2	下方向	93%
		全方向	93%

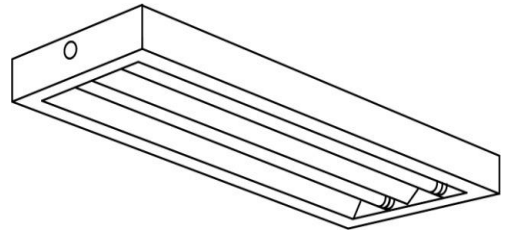

照明率表

		作業面照明率(×0.01)																						
反射率	天井	80								70				50				30				0		
		壁	70		50		30		10	70		50		30		10	50		30		10	30	10	0
	床	30	10	30	10	30	10	10	30	10	30	10	30	10	10	30	10	30	10	10	30	10	10	0
室 指 数	0.4	44	41	30	29	22	22	17	42	40	30	29	22	22	17	29	28	22	21	17	21	21	17	16
	0.6	60	55	45	43	36	35	30	58	54	45	42	36	35	30	43	41	35	34	29	35	34	29	27
	0.8	70	64	55	52	45	43	37	68	62	54	51	45	43	37	52	49	43	42	37	42	42	37	34
	1	79	71	64	59	54	51	45	76	69	63	58	53	51	45	60	57	52	50	44	50	49	44	42
	1.25	87	78	73	67	63	59	53	84	76	71	66	62	59	53	68	64	60	58	52	58	57	52	50
	1.5	93	82	79	72	69	64	58	89	80	77	71	68	64	58	73	69	66	63	57	64	61	57	54
	2	101	87	89	79	79	73	67	97	86	86	78	78	72	66	82	76	75	70	66	72	69	65	62
	2.5	106	91	96	85	87	79	73	102	90	93	83	85	78	73	88	81	81	76	72	78	75	71	68
	3	110	94	100	88	93	83	78	106	92	97	87	90	82	77	92	84	86	80	76	82	79	75	72
	4	114	97	107	92	100	88	84	110	96	103	91	97	87	83	97	89	92	85	82	88	84	81	78
5	118	99	111	95	105	92	88	113	98	107	94	102	91	87	101	92	97	89	86	92	87	85	82	
7	121	102	116	99	112	96	93	117	100	112	98	108	95	92	105	95	102	93	91	96	91	89	86	
10	124	104	120	101	117	99	97	119	102	116	100	113	98	96	108	98	106	96	95	100	94	93	90	

配光曲線

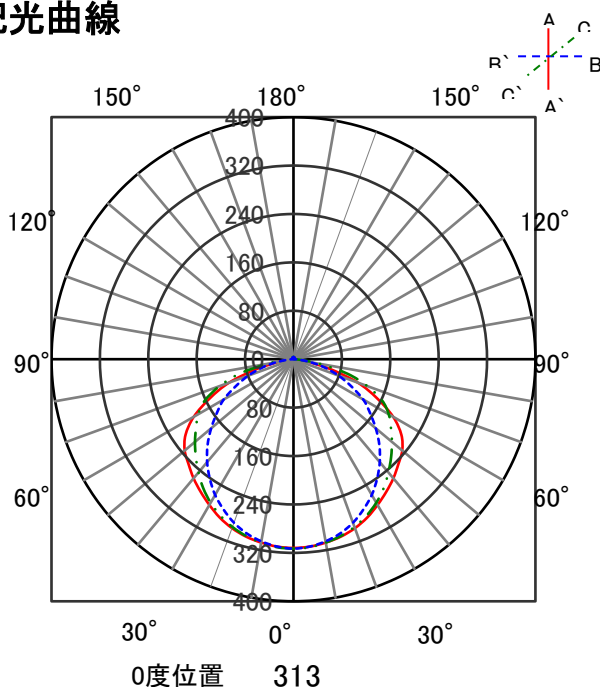

直射水平面照度

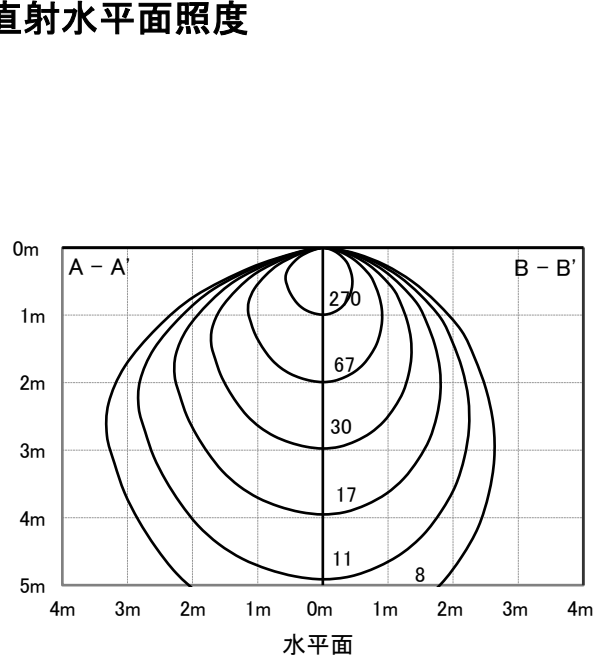

ECOHiLUX照明器具 配光データシート

意匠図

器具品名	直管用専用器具 逆富士型16形2灯	保守率	
器具品番	IRLDL162FJ-K	良	0.69
部品品名	-	中	0.67
部品品番	-	否	0.63
		器具効率	
器具光束	1700lm	上方向	4%
光源	LDG16T・WW/6/9/19SV/RK/C	下方向	90%
光源光束	900lm × 2	全方向	94%

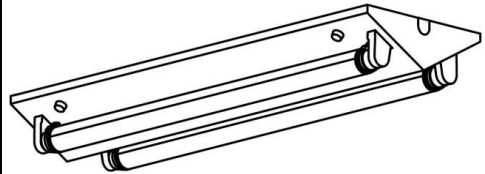

照明率表

反射率	天井	80				70				50				30				0						
		壁	70	50	30	10	70	50	30	10	50	30	10	30	10	10	30	10	10	0				
	床	30	10	30	10	30	10	30	10	30	10	30	10	30	10	30	10	30	10	10	0			
室 指 数	0.4	42	39	29	28	21	21	17	40	38	28	27	21	21	17	27	26	21	20	16	20	20	16	14
	0.6	57	53	43	41	35	34	28	55	51	42	40	34	33	28	41	39	33	33	28	32	32	28	25
	0.8	67	61	52	49	43	41	36	65	59	51	48	42	41	35	49	47	41	40	35	40	39	34	32
	1	75	67	61	57	51	49	43	72	66	59	55	50	48	42	56	54	49	47	42	47	46	41	39
	1.25	83	74	70	64	60	58	51	80	72	68	63	59	56	50	64	60	57	54	49	55	53	49	46
	1.5	88	77	75	68	66	61	55	85	76	73	67	64	60	55	69	65	62	59	54	59	57	53	50
	2	95	83	84	75	75	69	63	92	81	82	74	74	68	63	77	71	70	66	62	67	64	61	58
	2.5	101	87	91	80	83	74	70	97	85	88	79	80	73	69	82	76	76	72	68	73	70	66	63
	3	104	89	95	83	88	78	74	100	87	92	82	85	77	73	86	79	81	75	71	76	73	70	67
	4	108	92	101	88	95	83	79	104	90	98	86	92	82	79	91	83	86	80	77	82	78	75	72
5	111	94	105	90	100	87	83	107	92	101	89	96	85	82	94	86	90	83	80	85	81	79	75	
7	115	96	110	94	106	91	88	110	95	106	92	102	89	87	98	89	95	87	85	89	85	83	79	
10	117	98	114	96	111	94	92	113	97	109	95	107	93	91	101	92	99	90	88	93	88	86	83	

配光曲線

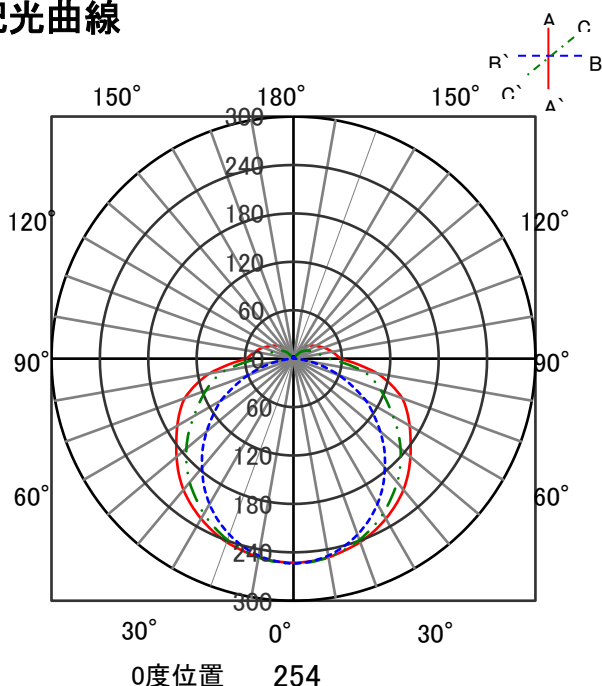

直射水平面照度

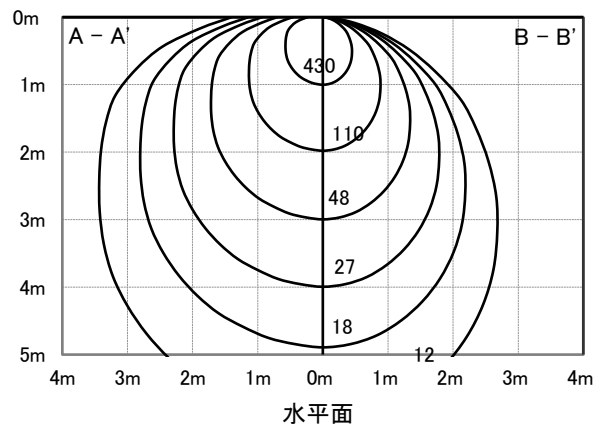

ECOHiLUX照明器具 配光データシート

意匠図

器具品名	直管型LEDランプ 専用器具 埋込下面開放型	保守率	
器具品番	IRLDL162UK-K	良	0.81
部品品名	-	中	0.77
部品品番	-	否	0.67
器具光束	1710lm	器具効率	
光源	LDG16T・WW/6/9/19SV/RK/C	上方向	0%
光源光束	900lm × 2	下方向	95%
		全方向	95%

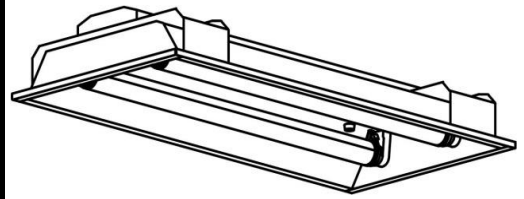

照明率表

		作業面照明率(×0.01)																						
反射率	天井 壁 床	80				70				50				30				0						
		70	10	30	10	30	10	30	10	50	10	30	10	30	10	30	10	30	10	30	10			
室 指 数	0.4	42	40	29	28	21	21	16	41	39	28	27	21	21	16	27	27	21	20	16	20	20	16	15
	0.6	58	53	43	41	35	34	28	56	52	43	41	34	33	28	41	40	34	33	28	33	32	28	26
	0.8	68	62	53	50	43	41	35	66	60	52	49	43	41	35	50	47	42	40	35	41	40	35	33
	1	76	68	62	57	52	49	43	74	67	60	56	51	48	43	57	54	49	48	42	48	47	42	40
	1.25	84	75	70	65	61	57	51	81	73	69	64	60	56	50	66	62	58	55	50	56	54	50	47
	1.5	89	79	76	69	66	62	56	86	77	74	68	65	61	55	71	66	63	60	55	61	59	54	52
	2	97	85	86	76	76	70	64	94	83	83	75	75	69	64	79	73	72	68	63	69	66	62	60
	2.5	103	88	92	82	84	76	70	99	87	90	80	82	75	70	85	78	78	73	69	75	72	68	65
	3	106	91	97	85	89	79	75	102	89	94	84	87	79	74	88	81	83	77	73	79	75	72	69
	4	111	94	103	89	97	85	81	107	93	100	88	94	84	80	94	86	89	82	79	84	80	78	75
5	114	96	107	92	102	88	85	110	95	104	91	99	87	84	97	89	93	86	83	88	84	81	79	
7	118	99	113	96	108	93	90	113	97	109	94	105	92	89	102	92	98	90	88	93	88	86	83	
10	120	101	117	98	113	96	94	116	99	112	97	109	95	93	105	95	102	93	91	96	91	90	87	

配光曲線

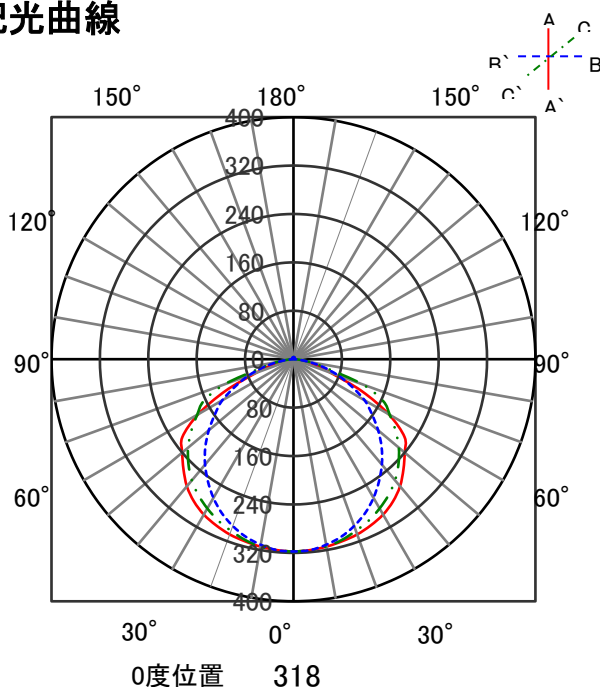

直射水平面照度

