

ECOHiLUX照明器具 配光データシート

意匠図

品名	ラインルクス	保守率	
セット品番	LX160F-17WW-UK40-W240-D	良	0.81
器具品名	埋込型	中	0.77
器具品番	LXBF-UK40-W240-D	否	0.68
器具光束	1785lm	器具効率	
光源	LXU160F-18WW-40S-D	上方向	0%
光源光束	1840lm	下方向	100%
		全方向	100%

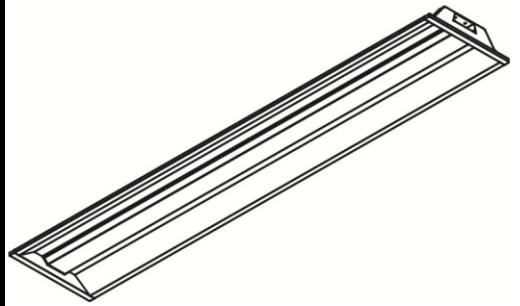

照明率表

		作業面照明率(×0.01)																												
反射率	天井	80								70				50				30				0								
		壁		70		50		30		10		70		50		30		10		50		30		10		30		10		0
	床	30	10	30	10	30	10	30	10	30	10	30	10	30	10	30	10	30	10	30	10	30	10	30	10	30	10	30	10	0
室 指 数	0.4	45	43	32	31	25	24	20	44	42	32	30	24	24	20	31	30	24	24	19	24	23	19	18						
	0.6	63	58	48	46	39	38	33	61	56	47	45	39	38	33	46	44	38	37	33	38	37	33	31						
	0.8	73	66	58	54	48	46	41	71	65	57	54	48	46	41	55	52	47	45	40	46	45	40	38						
	1	82	73	67	62	57	55	49	79	72	66	62	57	54	48	63	60	55	53	48	54	52	48	46						
	1.25	90	80	77	70	67	63	57	87	78	75	69	66	62	57	72	68	64	61	56	62	60	56	54						
	1.5	95	84	82	75	73	68	62	92	82	80	74	72	67	62	77	72	69	66	61	67	65	61	58						
	2	103	90	92	82	83	76	71	99	88	89	81	82	75	70	85	79	78	74	70	76	73	69	66						
	2.5	108	94	99	87	91	82	77	105	92	96	86	89	81	77	91	84	85	80	76	82	78	75	72						
	3	112	96	103	90	96	86	81	108	94	100	89	94	85	81	95	87	89	83	80	86	82	79	76						
	4	116	99	109	95	103	91	87	112	98	106	94	101	90	87	100	91	95	88	85	91	87	84	82						
5	119	101	113	97	108	94	91	115	100	110	96	105	93	91	103	94	100	92	89	94	90	88	85							
7	123	103	118	101	114	98	96	118	102	114	99	111	97	95	107	97	104	95	93	99	93	92	89							
10	125	105	122	103	119	101	100	121	103	118	102	115	100	99	110	100	108	98	97	102	96	95	92							

配光曲線

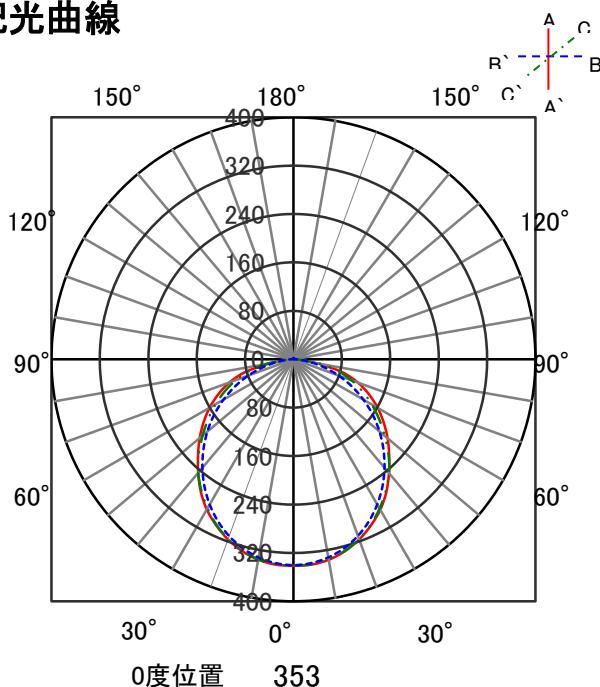

直射水平面照度

