

ECOHiLUX照明器具 配光データシート

意匠図

器具品名	直管用専用器具 直付下面開放型40形1灯	保守率	
器具品番	IRLDLFL41CL-K	良	0.69
部品品名	-	中	0.67
部品品番	-	否	0.63
器具光束	2970lm	器具効率	
光源	LDG32T・N/21/33/16SP	上方向	0%
光源光束	3300lm	下方向	90%
		全方向	90%

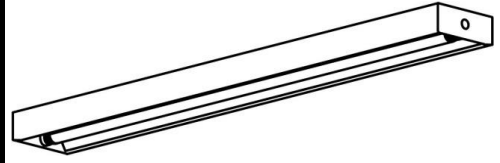

照明率表

作業面照明率(×0.01)

反射率(%)	天井	80								70								50				30				0	
		壁	70	50	30	10	70	50	30	10	70	50	30	10	50	30	10	30	10	30	10	0	0				
0.4	床	30	10	30	10	30	10	10	30	10	30	10	30	10	10	30	10	30	10	10	30	10	30	10	0	0	
0.6	0.4	45	43	32	31	24	24	19	44	42	31	30	24	24	19	30	30	24	23	19	23	23	19	17	17		
0.8	0.6	62	58	48	45	39	38	33	61	56	47	45	39	38	32	45	44	38	37	32	37	36	32	30	30		
1	0.8	73	66	58	54	48	46	40	70	64	56	53	47	46	40	54	52	46	45	40	45	44	39	37	37		
1.25	1	81	73	67	62	57	54	48	78	71	65	61	56	54	48	62	59	54	53	47	53	52	47	44	44		
1.5	1.25	90	80	76	70	66	62	57	86	78	74	69	65	62	56	71	67	63	61	56	61	59	55	52	52		
2	1.5	95	84	82	74	72	67	62	91	82	80	73	71	67	61	76	71	69	65	61	66	64	60	57	57		
2.5	2	103	89	91	82	83	75	70	99	88	89	81	81	75	70	84	78	78	73	69	74	72	68	65	65		
3	2.5	108	93	98	87	90	81	77	104	92	95	86	88	81	76	90	83	84	79	75	81	77	74	71	71		
4	3	112	96	103	90	96	85	81	107	94	100	89	93	84	80	94	86	89	83	79	84	81	78	75	75		
5	4	116	99	109	95	103	91	87	112	97	106	93	100	90	86	99	91	95	88	85	90	86	83	80	80		
7	5	119	101	113	97	108	94	91	115	99	109	96	105	93	90	103	93	99	91	88	94	89	87	84	84		
10	7	123	103	118	101	114	98	96	118	102	114	99	110	97	95	107	97	104	95	93	98	93	91	88	88		
	10	125	105	122	103	119	101	100	120	103	118	102	115	100	98	110	99	108	98	96	101	95	94	91	91		

配光曲線

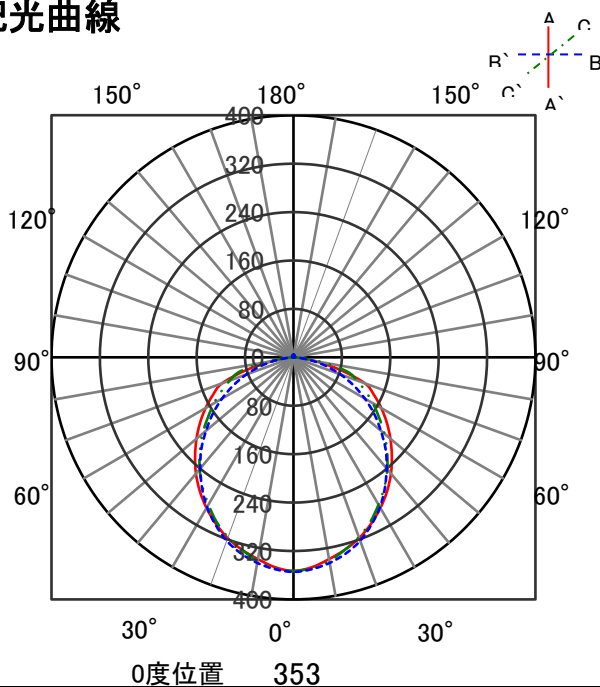

直射水平面照度

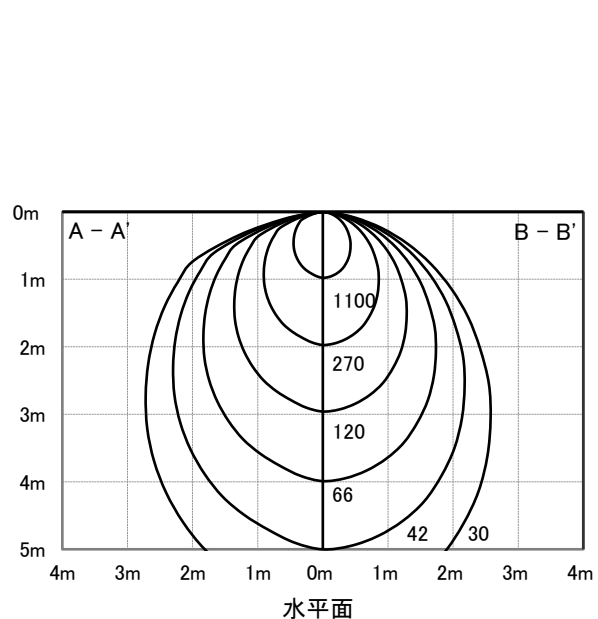

ECOHiLUX照明器具 配光データシート

意匠図

器具品名	直管用専用器具 逆富士型40形1灯	保守率	
器具品番	IRLDL41FJ-K	良	0.81
部品品名	-	中	0.77
部品品番	-	否	0.67
器具光束	3037lm	器具効率	
光源	LDG32T・N/21/33/16SP	上方向	3%
光源光束	3300lm	下方向	89%
		全方向	92%

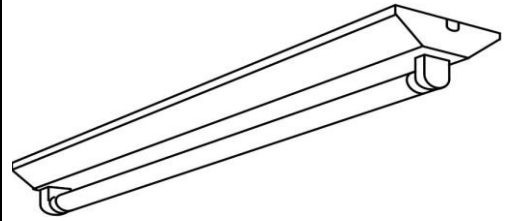

照明率表

		作業面照明率(×0.01)																						
反射率	天井	80								70				50				30		0				
	壁	70	50	30	10	70	50	30	10	70	50	30	10	50	30	10	30	10	30	10	0	0		
床	30	10	30	10	30	10	10	30	10	30	10	30	10	10	30	10	30	10	10	30	10	10	0	
室 指 数	0.4	42	40	28	28	21	20	16	40	38	27	26	20	20	15	25	24	18	18	14	17	16	13	10
	0.6	57	53	42	40	32	31	26	54	50	40	38	31	30	25	36	35	29	28	23	26	26	21	18
	0.8	67	61	51	48	41	39	33	63	58	49	46	39	38	32	44	42	36	35	29	33	32	27	23
	1	76	68	60	55	49	46	40	71	64	57	53	47	45	38	51	48	43	41	36	39	38	33	28
	1.25	84	74	68	63	57	54	47	78	71	65	60	55	52	45	58	55	50	48	42	45	44	39	33
	1.5	89	79	74	68	64	59	52	83	75	70	65	61	57	50	63	59	55	52	47	50	48	44	37
	2	97	85	84	75	74	67	61	91	80	79	72	70	65	59	71	66	63	60	55	57	55	51	43
	2.5	103	89	91	80	81	73	67	96	85	86	77	77	71	65	76	70	69	65	60	62	60	56	48
	3	107	91	96	84	87	78	72	100	87	90	81	82	75	69	80	74	74	69	64	66	63	60	51
	4	112	95	103	89	95	83	78	105	91	97	85	90	80	76	86	78	80	74	70	72	68	65	56
5	115	98	107	92	101	87	83	108	93	101	89	95	84	80	89	81	85	78	74	75	72	69	60	
7	119	100	113	96	108	92	89	112	96	106	92	101	89	86	94	85	90	82	79	80	76	73	64	
10	123	103	118	99	114	97	94	115	98	111	96	107	93	90	97	88	95	86	84	84	79	77	68	

配光曲線

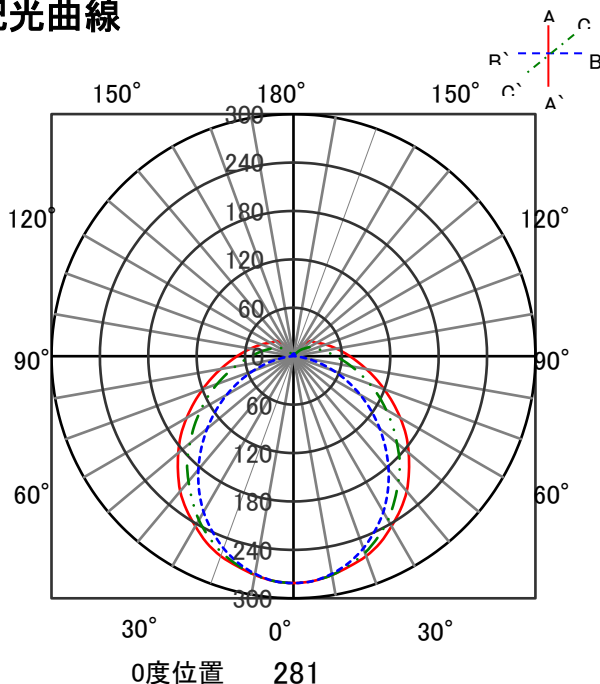

直射水平面照度

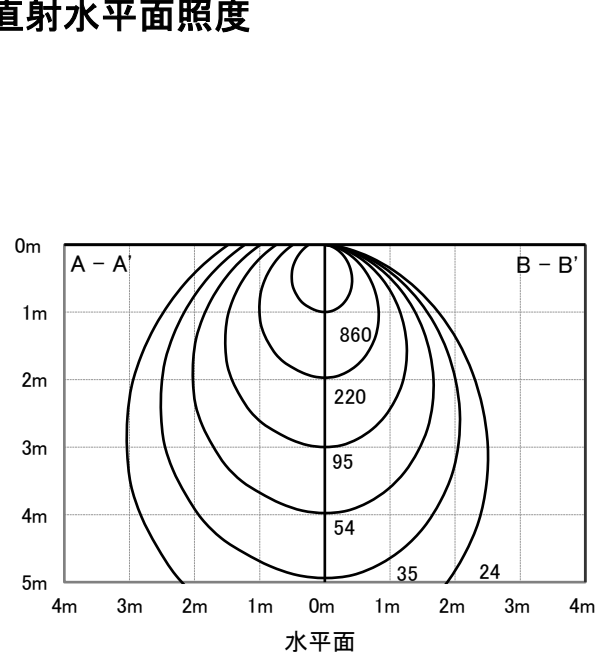

ECOHiLUX照明器具 配光データシート

意匠図

器具品名	直管用専用器具 トラフ型40形1灯	保守率	
器具品番	IRLDFL41TR-K	良	0.69
部品品名	-	中	0.67
部品品番	-	否	0.63
器具光束	3036lm	器具効率	
光源	LDG32T・N/21/33/16SP	上方向	8%
光源光束	3300lm	下方向	84%
		全方向	92%

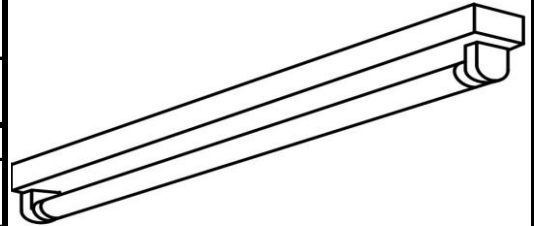

照明率表

作業面照明率(×0.01)

反射率(%)	天井	80								70								50				30				0	
		壁	70	50	30	10	70	50	30	10	50	30	10	30	10	30	10	30	10	0	0						
	床	30	10	30	10	30	10	10	30	10	30	10	30	10	10	30	10	30	10	30	10	0	0				
室 指 数	0.4	44	41	30	29	23	22	18	42	39	29	28	22	22	18	28	27	21	21	17	20	20	16	14			
	0.6	59	55	45	43	36	35	30	57	53	44	42	35	34	29	41	40	34	33	28	32	32	28	25			
	0.8	69	63	54	51	45	43	37	66	61	53	50	44	42	36	49	47	42	40	35	40	39	34	31			
	1	78	70	63	58	53	50	44	74	67	61	57	52	49	43	57	54	49	47	42	47	45	41	37			
	1.25	85	76	72	66	62	58	52	82	73	69	64	60	57	51	64	61	57	54	49	54	52	48	44			
	1.5	91	80	77	70	68	63	57	86	77	75	68	66	61	56	69	65	62	59	54	58	56	52	48			
	2	98	85	86	77	77	71	65	93	83	83	75	75	69	64	77	71	70	66	62	66	63	59	55			
	2.5	103	89	93	82	85	76	71	98	87	89	80	82	75	70	82	76	76	71	67	71	68	65	60			
	3	107	92	98	85	90	80	75	102	89	93	83	86	78	74	86	79	80	75	71	75	72	68	63			
	4	112	95	104	90	97	85	81	106	92	99	88	93	83	80	91	83	86	80	76	80	76	73	68			
5	115	97	108	93	102	89	85	109	94	103	90	98	87	83	94	86	90	83	80	83	79	77	71				
7	118	99	113	96	108	93	90	112	97	108	94	104	91	88	98	89	95	87	85	88	83	81	75				
10	121	101	117	99	113	96	94	115	99	112	96	108	94	92	102	92	99	90	88	91	86	85	79				

配光曲線

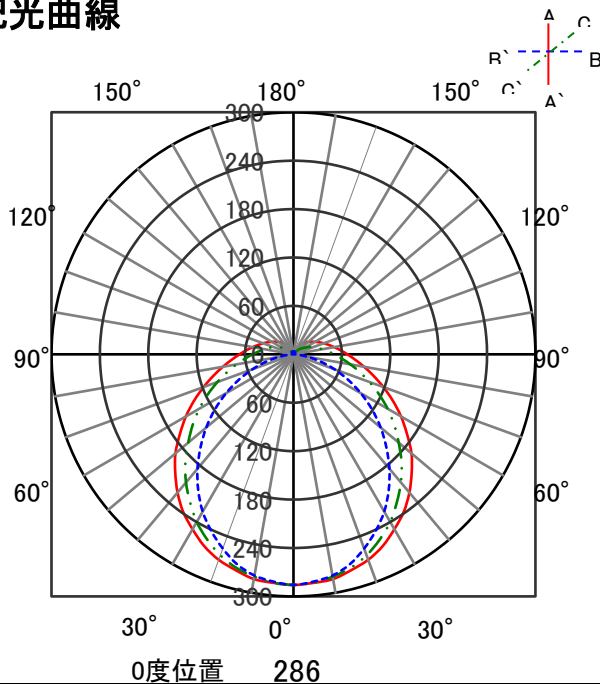

直射水平面照度

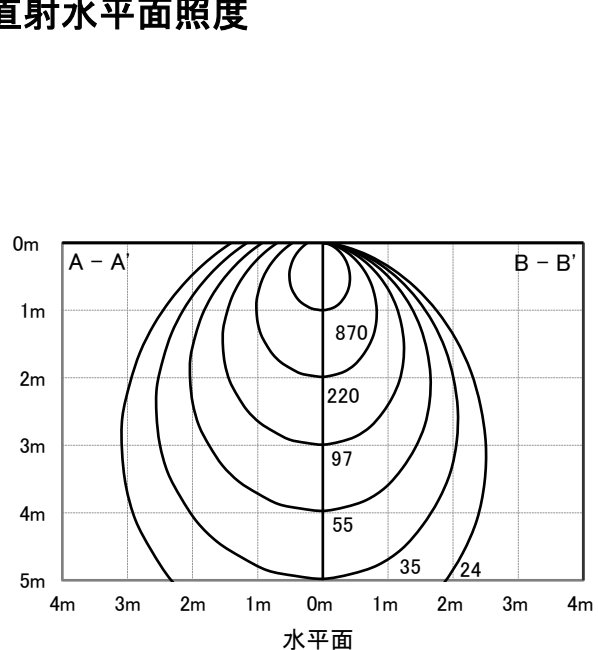

ECOHiLUX照明器具 配光データシート

意匠図

器具品名	直管用専用器具 埋込下面開放型40形1灯	保守率	
器具品番	IRLDLFL41UK-K	良	0.69
部品品名	-	中	0.67
部品品番	-	否	0.63
器具光束	3069lm	器具効率	
光源	LDG32T・N/21/33/16SP	上方向	0%
光源光束	3300lm	下方向	93%
		全方向	93%

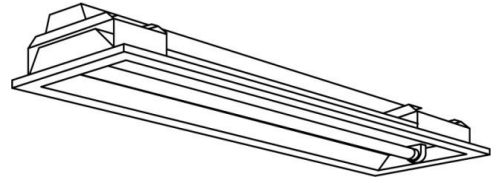

照明率表

		作業面照明率(×0.01)																			
反射率	天井	80				70				50				30				0			
		70	50	30	10	70	50	30	10	50	30	10	30	10	10	30	10	0			
	壁																				
	床	30	10	30	10	30	10	30	10	30	10	30	10	30	10	30	10	30	10	10	0
室 指 数	0.4	39	37	27	26	20	19	15	38	36	26	25	20	19	15	25	25	19	19	15	19
	0.6	54	50	40	38	32	31	26	52	48	40	38	32	31	26	38	37	31	31	26	31
	0.8	63	57	49	46	40	39	33	61	56	48	45	40	38	33	46	44	39	38	33	38
	1	71	64	57	53	48	46	40	68	62	56	52	47	45	40	53	51	46	44	39	45
	1.25	78	69	66	60	56	53	47	75	68	64	59	55	52	47	61	57	54	51	47	52
	1.5	83	73	71	64	62	57	52	80	72	69	63	61	57	52	66	62	59	56	51	57
	2	90	78	80	71	71	65	60	87	77	77	70	70	64	59	73	68	67	63	59	64
	2.5	95	82	86	76	78	70	66	92	81	83	75	76	70	65	79	73	73	68	64	70
	3	98	84	90	79	83	74	70	95	83	87	78	81	73	69	82	76	77	72	68	73
	4	103	87	96	83	90	79	75	99	86	93	82	87	78	75	87	80	83	76	74	79
5	106	89	100	86	95	82	79	102	88	96	85	92	81	78	90	82	87	80	77	82	
7	109	92	104	89	100	86	84	105	90	101	88	97	85	83	94	86	91	83	81	86	
10	112	93	108	91	105	89	87	107	92	104	90	102	88	87	97	88	95	86	85	90	

配光曲線

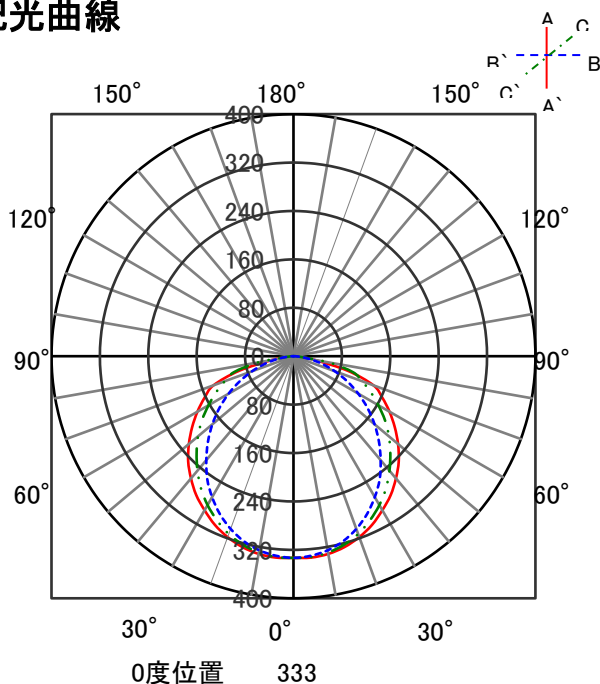

直射水平面照度

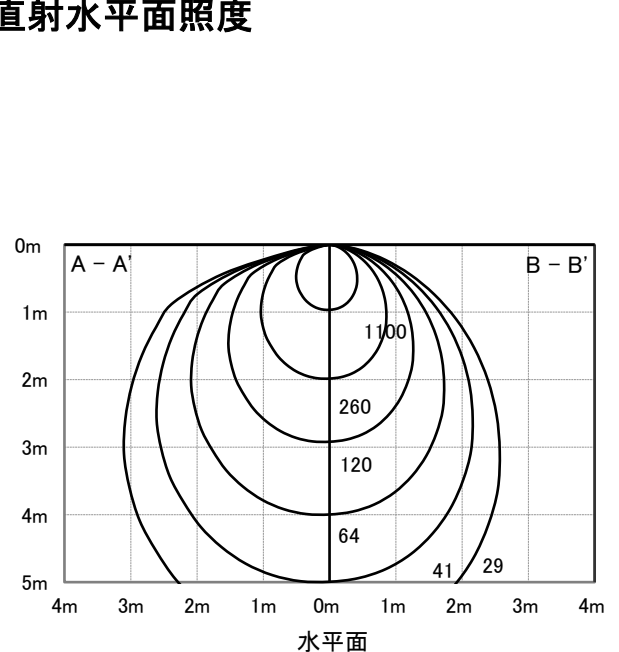

ECOHiLUX照明器具 配光データシート

意匠図

器具品名	直管用専用器具 直付下面開放型40形2灯	保守率	
器具品番	IRLDL42CL-K	良	0.69
部品品名	-	中	0.67
部品品番	-	否	0.63
器具光束	6138lm	器具効率	
光源	LDG32T・N/21/33/16SP	上方向	0%
光源光束	3300lm × 2	下方向	93%
		全方向	93%

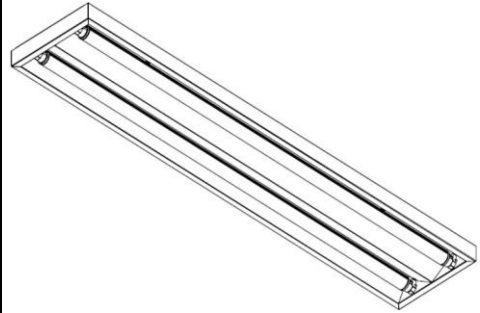

照明率表

作業面照明率(×0.01)

反射率(%)	天井	80								70								50				30				0	
		壁	70	50	30	10	70	50	30	10	70	50	30	10	50	30	10	30	10	30	10	0	0				
0.4	床	30	10	30	10	30	10	10	30	10	30	10	30	10	10	30	10	30	10	10	30	10	10	30	10	0	
0.6	0.4	45	42	31	30	24	23	19	44	41	31	30	24	23	19	30	29	23	23	19	23	22	18	17	17		
0.8	0.6	62	57	47	45	38	37	32	60	56	46	44	38	37	32	45	43	37	36	31	36	36	31	29	29		
1	0.8	72	65	57	54	47	45	40	70	64	56	53	47	45	39	54	51	46	44	39	45	44	39	36	36		
1.25	1	81	73	66	62	56	54	48	78	71	65	61	56	53	47	62	59	54	52	47	53	51	46	44	44		
1.5	1.25	89	79	76	69	66	62	56	86	78	74	68	65	61	56	71	66	63	60	55	61	59	55	52	52		
2	1.5	95	83	82	74	72	67	61	91	82	80	73	71	66	61	76	71	68	65	60	66	64	60	57	57		
2.5	2	103	89	91	82	83	75	70	99	87	89	80	81	75	70	84	78	77	73	69	74	72	68	65	65		
3	2.5	108	93	98	87	90	81	77	104	91	95	86	88	81	76	90	83	84	79	75	81	77	74	71	71		
4	3	112	96	103	90	96	85	81	107	94	100	89	93	84	80	94	86	89	83	79	84	81	78	75	75		
5	4	116	99	109	94	103	91	87	112	97	106	93	100	90	86	99	91	95	88	85	90	86	83	80	80		
7	5	119	101	113	97	108	94	91	115	99	109	96	105	93	90	103	93	99	91	88	94	89	87	84	84		
10	7	123	103	118	100	114	98	96	118	102	114	99	110	97	95	107	97	104	95	93	98	93	91	88	88		
	10	125	105	122	103	119	101	99	120	103	118	102	115	100	98	110	99	108	98	96	101	96	94	91	91		

配光曲線

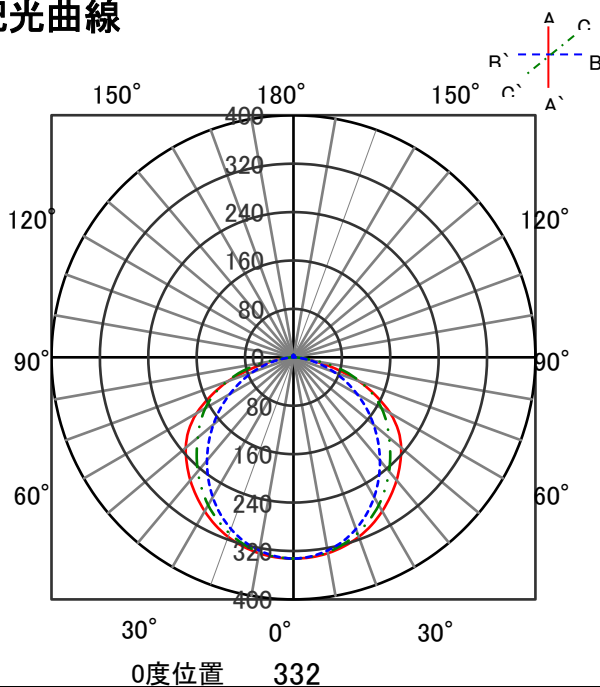

直射水平面照度

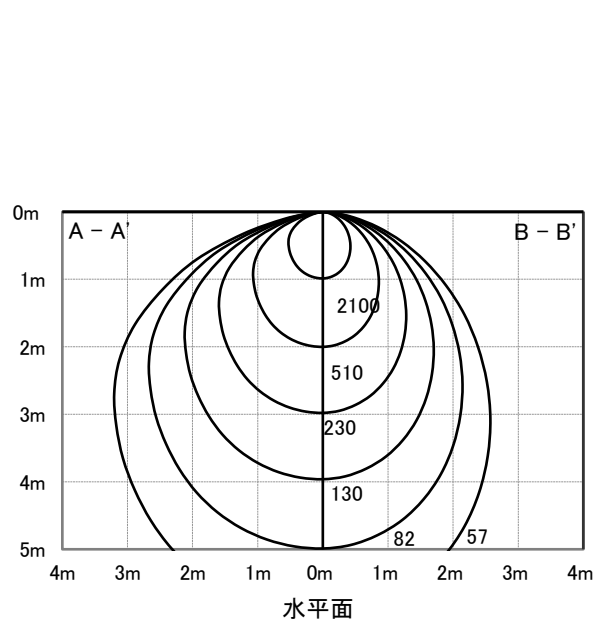

ECOHiLUX照明器具 配光データシート

意匠図

器具品名	直管用専用器具 ウォールウォッシャー型40形2	保守率	
器具品番	IRLDFL42CLWW-K	良	0.69
部品品名	-	中	0.67
部品品番	-	否	0.63
器具光束	5915lm	器具効率	
光源	LDG32T・N/21/33/16SP	上方向	3%
光源光束	3300lm × 2	下方向	86%
		全方向	90%

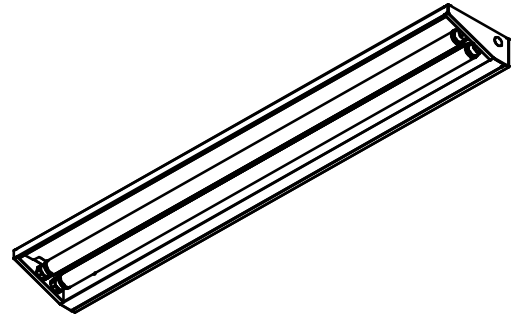

照明率表

		作業面照明率(×0.01)																								
反射率	天井	80								70								50				30				0
	壁	70		50		30		10	70		50		30		10	50		30		10	30		10	0		
	床	30	10	30	10	30	10	10	30	10	30	10	30	10	10	30	10	30	10	10	30	10	10	30	10	0
室 指 数	0.4	43	40	29	28	22	21	17	41	39	29	28	21	21	16	27	27	21	20	16	20	20	16	14		
	0.6	59	54	44	42	35	34	28	57	53	43	41	34	33	28	41	39	33	32	27	32	32	27	25		
	0.8	69	62	53	50	43	41	35	66	60	52	49	42	41	35	49	47	41	40	34	39	39	34	31		
	1	77	69	62	57	51	49	42	74	67	60	56	50	48	42	57	54	49	47	41	47	46	41	38		
	1.25	85	76	71	65	60	57	50	82	73	69	63	59	56	50	65	61	57	54	49	54	53	48	45		
	1.5	90	80	76	69	66	62	55	87	77	74	68	65	61	55	70	65	62	59	54	59	57	52	49		
	2	98	85	86	77	76	70	64	94	83	83	75	74	68	63	78	72	70	66	61	67	64	60	57		
	2.5	104	89	93	82	84	75	70	99	87	89	80	81	74	69	83	77	72	68	63	73	70	66	62		
	3	107	92	97	85	89	79	74	103	90	94	84	86	78	73	87	80	81	76	72	77	73	70	66		
	4	112	95	104	90	97	85	80	107	93	100	88	93	84	79	93	85	88	81	77	82	78	75	71		
5	115	97	108	93	102	89	85	110	95	104	91	98	87	84	96	88	92	84	81	86	82	79	75			
7	119	100	113	96	108	93	90	114	98	109	95	104	92	89	101	91	97	89	86	91	86	84	80			
10	122	102	118	99	114	97	94	117	100	113	98	109	95	93	104	94	102	92	90	95	89	88	84			

配光曲線

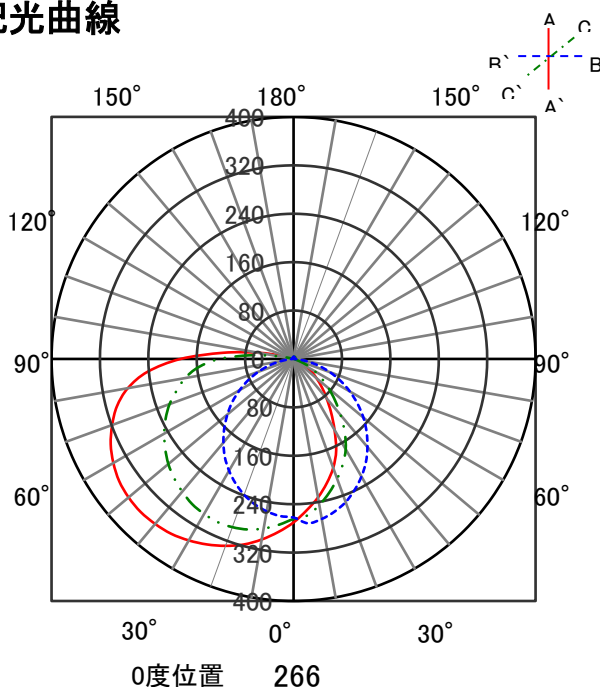

直射水平面照度

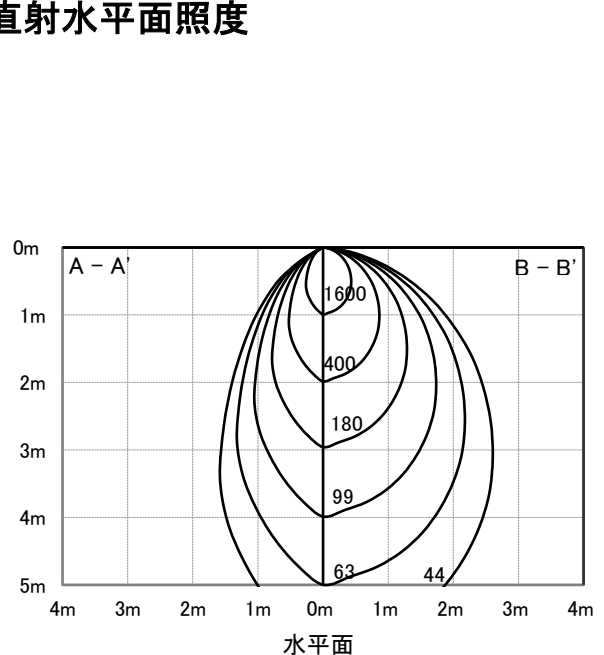

ECOHiLUX照明器具 配光データシート

意匠図

器具品名	直管用専用器具 逆富士型40形2灯	保守率	
器具品番	IRLDL42FJ-K	良	0.69
部品品名	-	中	0.67
部品品番	-	否	0.63
器具光束	6204lm	器具効率	
光源	LDG32T・N/21/33/16SP	上方向	4%
光源光束	3300lm × 2	下方向	90%
		全方向	94%

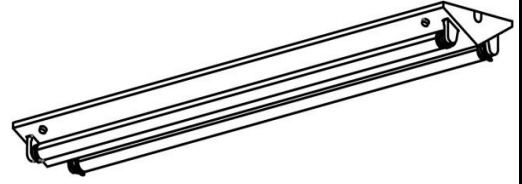

照明率表

		作業面照明率(×0.01)																											
反射率	天井	80								70								50				30				0			
	壁	70	10	30	10	30	10	30	10	70	10	30	10	30	10	30	10	50	30	10	10	30	10	10	10	30	10	10	10
室 指 数	0.4	42	40	28	28	21	20	16	40	38	27	26	20	20	15	25	24	18	18	14	17	16	13	10					
	0.6	57	53	42	40	32	31	26	54	50	40	38	31	30	25	36	35	29	28	23	26	26	21	18					
	0.8	67	61	51	48	41	39	33	63	58	49	46	39	38	32	44	42	36	35	29	33	32	27	23					
	1	76	68	60	55	49	46	40	71	64	57	53	47	45	38	51	48	43	41	36	39	38	33	28					
	1.25	84	74	68	63	57	54	47	78	71	65	60	55	52	45	58	55	50	48	42	45	44	39	33					
	1.5	89	79	74	68	64	59	52	83	75	70	65	61	57	50	63	59	55	52	47	50	48	44	37					
	2	97	85	84	75	74	67	61	91	80	79	72	70	65	59	71	66	63	60	55	57	55	51	43					
	2.5	103	89	91	80	81	73	67	96	85	86	77	77	71	65	76	70	69	65	60	62	60	56	48					
	3	107	91	96	84	87	78	72	100	87	90	81	82	75	69	80	74	74	69	64	66	63	60	51					
	4	112	95	103	89	95	83	78	105	91	97	85	90	80	76	86	78	80	74	70	72	68	65	56					
5	115	98	107	92	101	87	83	108	93	101	89	95	84	80	89	81	85	78	74	75	72	69	60						
7	119	100	113	96	108	92	89	112	96	106	92	101	89	86	94	85	90	82	79	80	76	73	64						
10	123	103	118	99	114	97	94	115	98	111	96	107	93	90	97	88	95	86	84	84	79	77	68						

配光曲線

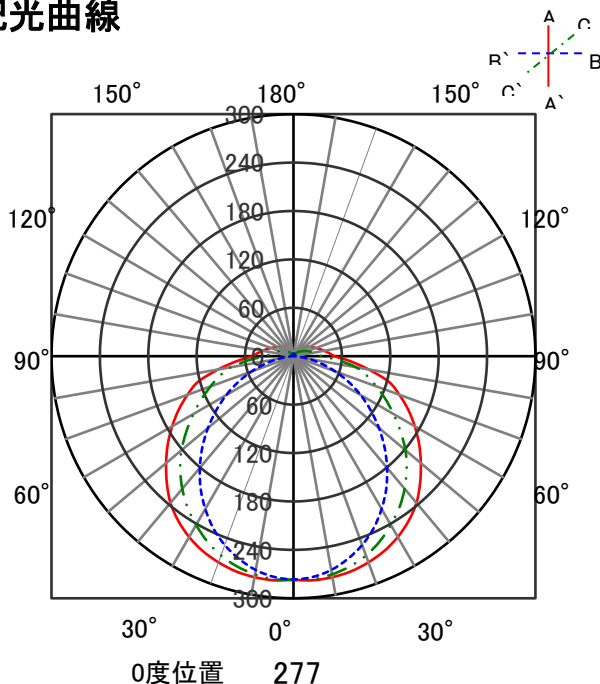

直射水平面照度

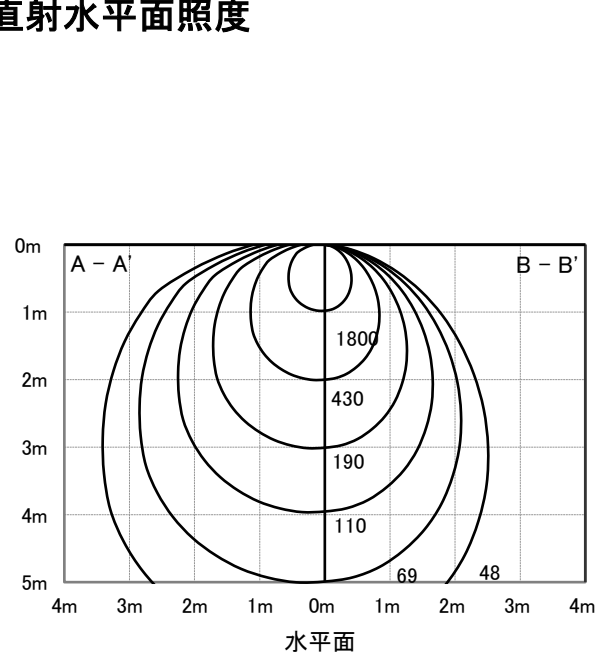

ECOHiLUX照明器具 配光データシート

意匠図

器具品名	直管用専用器具 トラフ型40形2灯	保守率	
器具品番	IRLDL42TR-K	良	0.69
部品品名	-	中	0.67
部品品番	-	否	0.63
器具光束	6072lm	器具効率	
光源	LDG32T・N/21/33/16SP	上方向	0%
光源光束	3300lm × 2	下方向	92%
		全方向	92%

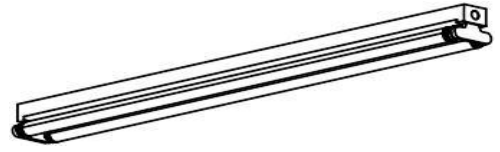

照明率表

作業面照明率(×0.01)

反射率(%)	天井	80								70								50				30				0	
		壁	70	50	30	10	70	50	30	10	70	50	30	10	50	30	10	30	10	30	10	0	0				
0.4	床	30	10	30	10	30	10	10	30	10	30	10	30	10	10	30	10	30	10	10	30	10	10	0	0		
0.4	壁	44	41	30	29	23	22	18	42	40	30	29	23	22	18	28	27	22	21	17	21	21	17	15			
0.6	床	60	55	45	43	36	35	30	58	53	44	42	36	35	30	42	40	35	34	29	33	33	28	26			
0.6	壁	70	63	55	51	45	43	37	67	61	53	50	44	42	37	50	48	42	41	36	41	40	35	32			
1	床	78	70	63	59	54	51	45	75	68	62	58	52	50	44	58	55	50	48	43	48	47	42	39			
1	壁	86	77	72	66	63	59	53	83	74	70	65	61	58	52	66	62	58	56	51	55	54	49	46			
1.5	床	91	81	78	71	68	64	58	87	78	76	69	67	62	57	71	66	63	60	55	60	58	54	50			
1.5	壁	99	86	87	78	78	72	66	95	84	84	76	76	70	65	78	73	72	68	63	68	65	61	57			
2.5	床	104	90	94	83	86	77	72	100	88	91	81	83	76	71	84	78	78	73	69	73	70	67	63			
2.5	壁	108	93	99	87	91	81	76	103	90	95	85	88	80	75	88	81	82	77	73	77	74	71	66			
4	床	113	96	105	91	98	86	82	107	93	101	89	95	85	81	93	85	88	82	78	82	79	76	71			
4	壁	116	98	109	94	103	90	86	110	96	105	92	99	88	85	96	88	92	85	82	86	82	79	75			
7	床	119	100	114	97	110	94	91	114	98	109	95	105	92	90	100	91	97	89	87	90	86	84	79			
7	壁	122	102	118	100	115	98	96	116	100	113	98	110	96	94	104	94	101	92	90	94	89	87	82			

配光曲線

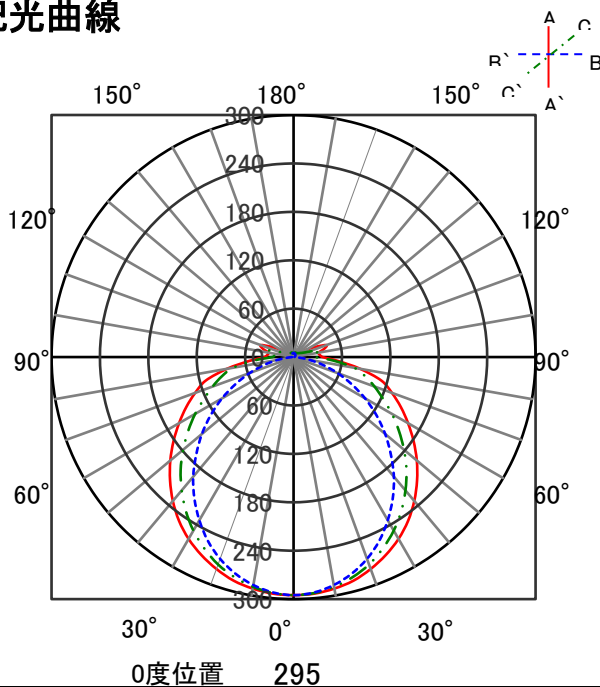

直射水平面照度

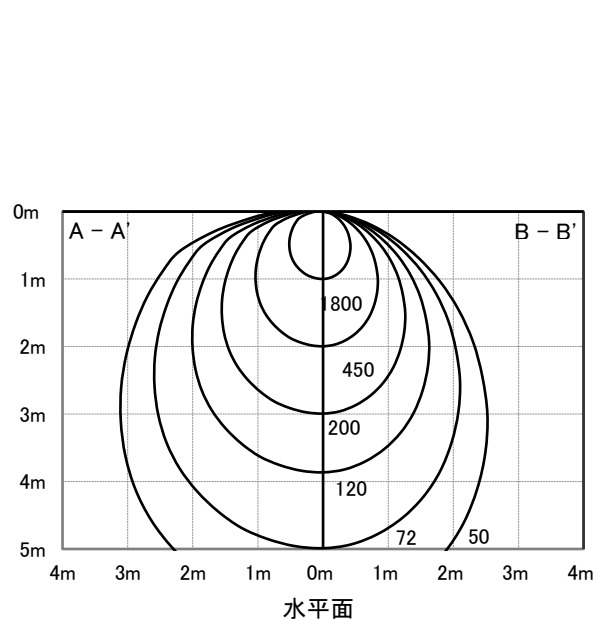

ECOHiLUX照明器具 配光データシート

意匠図

器具品名	直管用専用器具 埋込下面開放型40形2灯	保守率	
器具品番	IRLDFL42UK-K	良	0.69
部品品名	-	中	0.67
部品品番	-	否	0.63
器具光束	6270lm	器具効率	
光源	LDG32T・N/21/33/16SP	上方向	0%
光源光束	3300lm × 2	下方向	95%
		全方向	95%



照明率表

作業面照明率(×0.01)

反(天井)	80								70								50				30				0				
	壁		70		50		30		10		70		50		30		10		50		30		10		30		10		0
射率)	床		30	10	30	10	30	10	10	30	10	30	10	30	10	30	10	30	10	30	10	30	10	30	10	30	10	30	
室	0.4	45	43	32	31	24	24	19	44	42	31	30	24	24	19	30	30	24	23	19	23	23	19	18					
指	0.6	63	58	48	46	40	38	33	61	57	48	45	39	38	33	46	44	38	38	33	38	37	33	31					
数	0.8	73	67	59	55	49	47	41	71	65	57	54	49	47	41	55	53	47	46	41	46	45	41	39					
	1	82	74	68	63	58	55	50	80	72	67	62	58	55	49	64	61	56	54	49	55	53	49	47					
	1.25	91	81	78	71	68	64	58	88	79	76	70	67	64	58	73	69	65	63	58	63	62	57	55					
	1.5	96	85	84	76	75	69	64	93	83	82	75	73	69	63	78	73	71	68	63	69	66	62	60					
	2	104	91	93	83	85	77	72	100	89	91	82	83	77	72	86	80	80	75	71	77	74	71	68					
	2.5	109	94	100	88	92	83	79	106	93	97	87	90	83	78	92	85	87	81	78	83	80	77	74					
	3	113	97	105	92	98	87	83	109	95	102	91	95	86	83	96	88	91	85	81	87	83	80	78					
	4	117	100	111	96	105	92	89	113	98	107	95	102	91	88	101	92	97	90	87	92	88	86	83					
	5	120	102	115	98	110	95	93	116	100	111	97	107	95	92	104	95	101	93	90	96	91	89	86					
	7	123	104	119	101	115	99	97	119	102	115	100	112	98	96	108	98	105	96	95	100	94	93	90					
	10	126	105	123	104	120	102	101	121	104	119	103	116	101	100	111	100	109	99	98	103	97	96	93					

配光曲線

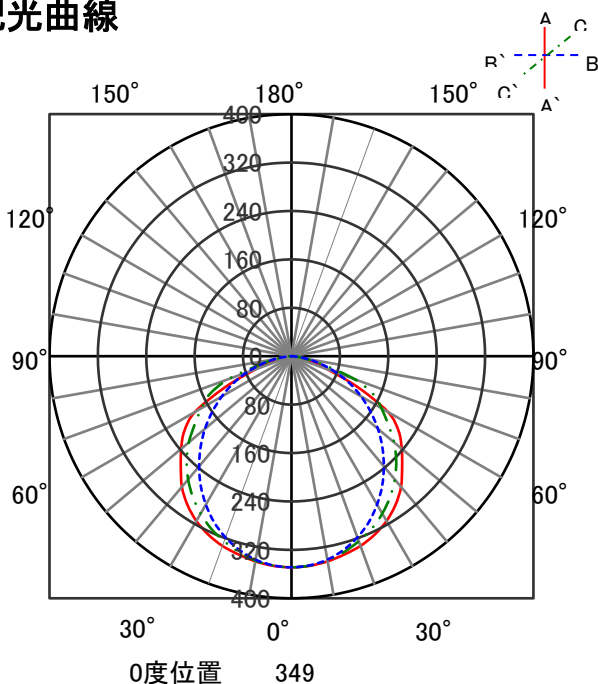

直射水平面照度

