

ECOHiLUX照明器具 配光データシート

意匠図

器具品名	高天井LED照明	保守率	
器具品番	CL5M-300W-110-K50-R7-TC	良	-
部品品名	-	中	-
部品品番	-	否	-
		器具効率	
器具光束	46500lm	上方向	1%
光源	-	下方向	99%
光源光束	一体型器具のため、器具光束表示	全方向	100%

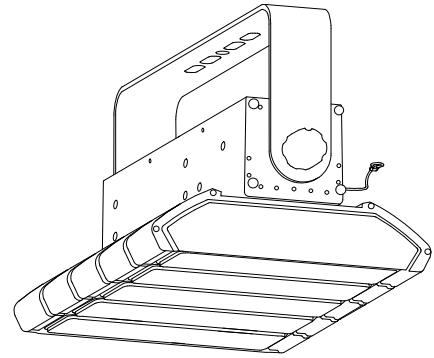

照明率表

		作業面照明率(×0.01)																										
反射率	天井	80								70								50				30				0		
	壁	70		50		30		10		70		50		30		10		50		30		10		30		10		0
	床	30	10	30	10	30	10	30	10	30	10	30	10	30	10	30	10	30	10	30	10	30	10	30	10	30	10	0
室 指 数	0.4	46	43	33	32	25	25	20	45	42	32	31	25	25	20	31	30	25	24	20	24	24	20	18				
	0.6	64	59	50	47	41	40	35	62	58	49	47	41	40	35	47	46	40	39	34	39	39	34	32				
	0.8	75	68	60	56	51	49	43	72	66	59	56	50	48	43	57	54	49	48	43	48	47	42	40				
	1	84	75	70	65	60	57	52	81	74	68	64	60	57	51	66	62	58	56	51	57	55	51	48				
	1.25	92	82	79	73	70	66	61	89	80	78	72	69	65	60	74	70	67	64	60	65	63	59	57				
	1.5	97	86	85	78	76	71	66	94	84	83	76	75	70	65	80	75	73	69	65	70	68	64	62				
	2	105	91	95	85	86	79	74	101	90	92	84	85	78	74	88	81	81	77	73	78	76	72	70				
	2.5	110	95	101	89	94	85	80	106	94	98	88	92	84	80	93	86	88	82	79	84	81	78	75				
	3	114	97	106	92	99	88	84	110	96	102	91	96	87	84	97	89	92	86	83	88	84	81	79				
	4	118	100	111	96	106	93	90	114	99	108	95	103	92	89	102	93	98	90	88	93	88	86	84				
5	121	102	115	99	110	96	93	116	101	111	98	107	95	92	105	95	101	93	91	96	91	89	87					
7	124	104	119	102	116	99	97	119	103	115	100	112	98	96	108	98	106	96	95	100	94	93	90					
10	126	105	123	104	120	102	101	121	104	119	102	116	101	100	111	100	109	99	98	102	97	96	93					

配光曲線

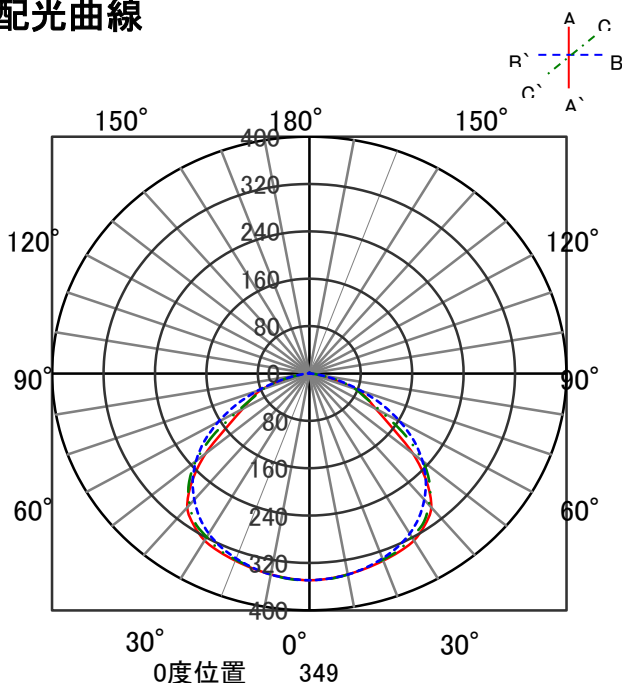

直射水平面照度

