

ECOHiLUX照明器具 配光データシート

意匠図

器具品名	直管用専用器具 直付下面開放型20形1灯			保守率	
器具品番	IRLDFL21CL			良	0.69
部品品名	直管LEDランプ° HE190S			中	0.67
部品品番	LDG20T・WW/6/9/19SL/R			否	0.63
器具光束	882lm	最大取付間隔		器具効率	
光源	LED	AA		上方向	0%
光源光束	900lm	BB		下方向	98%
				全方向	98%

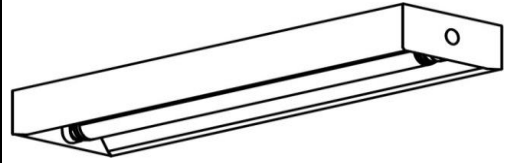

照明率表

作業面照明率(×0.01)

反 射 率	天井	80								70								50				30				0	
		70	50	30	10	70	50	30	10	70	50	30	10	50	30	10	30	10	30	10	0	0					
0.4	壁	30	10	30	10	30	10	10	30	10	30	10	30	10	10	30	10	30	10	10	30	10	0	0			
0.6	床	45	42	32	31	24	24	19	44	41	31	30	24	24	19	30	29	24	23	19	23	23	19	17			
0.8		62	57	48	45	39	38	33	61	56	47	45	39	38	32	45	44	38	37	32	37	36	32	30			
1		73	66	58	54	48	46	40	70	64	57	53	48	46	40	54	52	46	45	40	45	44	40	37			
1.3		81	73	67	62	57	54	49	79	72	66	61	57	54	48	63	60	55	53	48	53	52	47	45			
1.5		90	80	77	70	67	63	57	87	78	75	69	66	62	57	71	67	64	61	56	62	60	56	53			
2		95	84	83	75	73	68	62	92	82	81	74	72	67	62	77	72	69	66	61	67	65	61	58			
2.5		103	90	92	82	83	76	71	99	88	90	81	82	75	71	85	79	78	74	70	75	72	69	66			
3		109	94	99	87	91	82	78	105	92	96	86	89	81	77	91	84	85	80	76	81	78	75	72			
3		112	96	104	91	96	86	82	108	94	100	89	94	85	81	95	87	89	83	80	85	82	79	76			
4		117	99	110	95	104	91	88	112	98	106	94	101	90	87	100	91	95	88	86	91	86	84	81			
5		120	101	114	98	109	95	92	115	100	110	96	105	94	91	103	94	100	92	89	94	90	88	85			
7		123	103	119	101	115	99	96	118	102	114	100	111	97	95	107	97	104	95	93	98	93	92	89			
10		125	105	122	103	119	102	100	121	104	118	102	115	100	99	110	99	108	98	97	101	96	95	92			

配光曲線

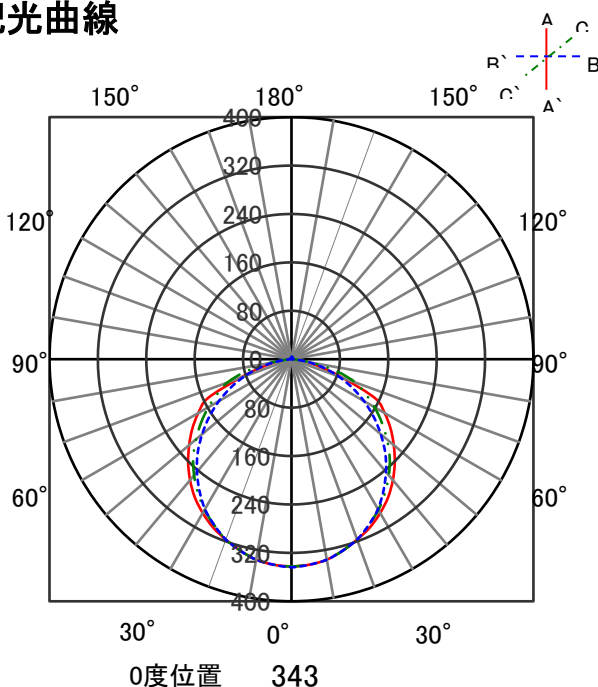

直射水平面照度

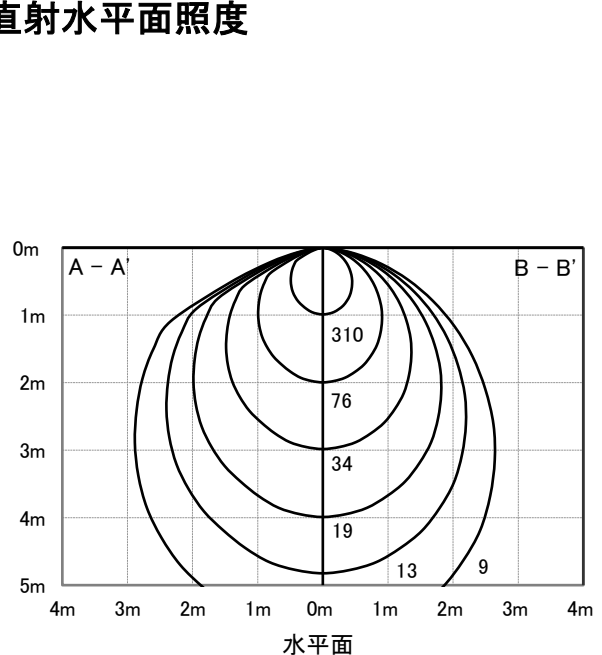

ECOHiLUX照明器具 配光データシート

意匠図

器具品名	直管用専用器具 逆富士型20形1灯			保守率	
器具品番	IRLDL21FJ			良	0.69
部品品名	直管LEDランプ° HE190S			中	0.67
部品品番	LDG20T・WW/6/9/19SL/R			否	0.63
器具光束	828lm	最大取付間隔		器具効率	
光源	LED	AA		上方向	8%
光源光束	900lm	BB		下方向	84%
				全方向	92%

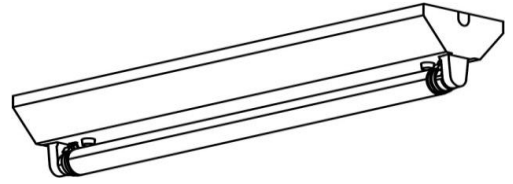

照明率表

作業面照明率(×0.01)

反天井 %射率	80								70								50				30		0					
	壁	70	50	30	10	70	50	30	10	70	50	30	10	50	30	10	30	10	0	30	10	0						
床	30	10	30	10	30	10	10	30	10	30	10	30	10	30	10	10	30	10	10	30	10	30	10	10	30	10	10	0
室 指 数	0.4	44	41	31	29	23	23	18	42	40	30	29	23	22	18	28	27	22	21	17	21	21	17	15				
	0.6	60	55	46	43	37	36	30	58	53	44	42	36	35	30	42	40	35	34	29	33	33	28	26				
	0.8	70	64	55	52	45	44	38	67	61	53	50	44	43	37	50	48	42	41	36	40	40	35	32				
	1	78	70	64	59	54	51	45	75	68	62	58	53	50	45	58	55	50	48	43	48	46	42	38				
	1.3	86	77	73	67	63	59	53	82	74	70	65	61	58	52	65	62	58	56	51	55	53	49	45				
	1.5	91	81	78	71	69	64	58	87	78	76	69	67	63	57	70	66	63	60	55	60	58	53	49				
	2	99	86	87	78	78	72	66	94	83	84	76	76	70	65	78	72	71	67	63	67	64	61	56				
	2.5	104	90	94	83	86	77	72	99	87	90	81	83	76	71	83	77	77	73	69	72	69	66	61				
	3	108	92	98	86	91	81	76	102	90	94	84	88	79	75	87	80	81	76	72	76	73	70	65				
	4	112	95	105	91	98	86	82	107	93	100	88	94	84	81	92	84	87	81	78	81	77	75	69				
5	115	97	109	93	103	90	86	109	95	104	91	99	88	84	95	87	91	84	81	84	80	78	72					
7	119	100	114	97	109	94	91	113	97	108	94	104	92	89	99	90	96	88	85	88	84	82	76					
10	121	102	118	99	114	97	95	115	99	112	97	109	95	93	102	92	100	91	89	92	87	85	79					

配光曲線

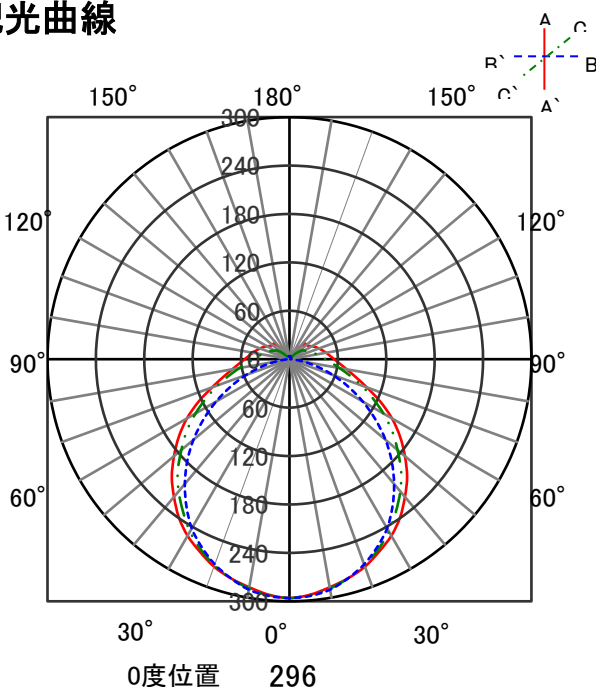

直射水平面照度

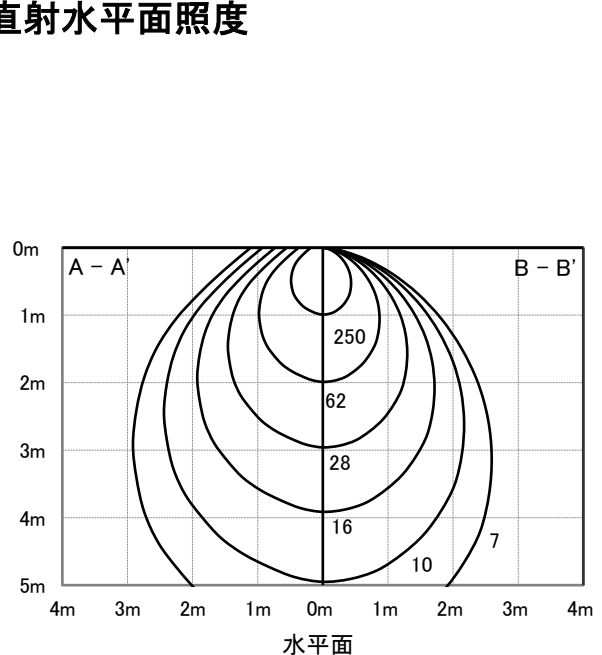

ECOHiLUX照明器具 配光データシート

意匠図

器具品名	直管用専用器具 トラフ型20形1灯			保守率	
器具品番	IRLDFL21TR			良	0.69
部品品名	直管LEDランプ° HE190S			中	0.67
部品品番	LDG20T・WW/6/9/19SL/R			否	0.63
器具光束	828lm	最大取付間隔		器具効率	
光源	LED	AA		上方向	8%
光源光束	900lm	BB		下方向	84%
				全方向	92%

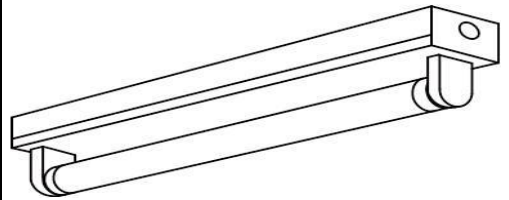

照明率表

作業面照明率(×0.01)

反 射 率	80								70								50				30		0	
	天井	70		50		30		10		天井	70		50		30		10		床	30		10		0
0.4	44	41	31	30	23	23	18	42	40	30	29	23	22	18	28	28	22	22	18	21	21	17	15	
0.6	60	55	46	44	37	36	31	58	54	45	42	36	35	30	42	40	35	34	29	33	33	29	26	
0.8	70	64	55	52	46	44	38	67	62	54	51	45	43	38	50	48	43	41	36	41	40	35	32	
1	78	70	64	59	54	51	45	75	68	62	58	53	50	45	58	55	50	49	44	48	47	42	39	
1.25	86	77	73	67	63	59	53	83	74	70	65	62	58	53	66	62	58	56	51	55	54	50	46	
1.5	92	81	79	71	69	64	58	87	78	76	70	67	63	57	71	66	63	60	56	60	58	54	50	
2	99	86	88	78	79	72	66	94	84	84	76	76	70	65	78	73	72	68	63	67	65	61	57	
2.5	104	90	94	83	86	78	73	99	87	90	81	83	76	71	84	77	78	73	69	73	70	66	62	
3	108	92	99	86	91	81	77	103	90	95	84	88	80	75	87	80	82	76	73	76	73	70	65	
4	112	96	105	91	98	86	82	107	93	100	89	94	85	81	92	84	88	81	78	81	77	75	70	
5	115	98	109	93	103	90	86	110	95	104	91	99	88	85	95	87	91	84	81	85	80	78	73	
7	119	100	114	97	109	94	91	113	97	109	94	105	92	89	99	90	96	88	86	89	84	82	77	
10	121	102	118	99	114	97	95	115	99	112	97	109	95	93	102	93	100	91	89	92	87	86	80	

配光曲線

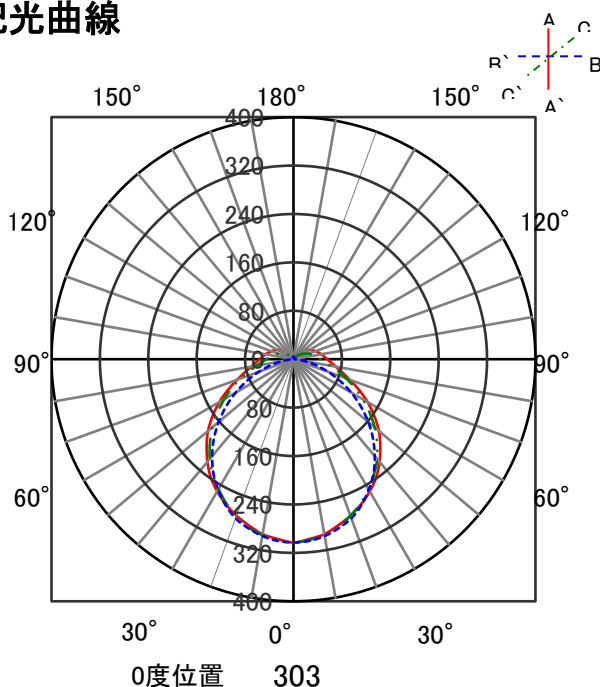

直射水平面照度

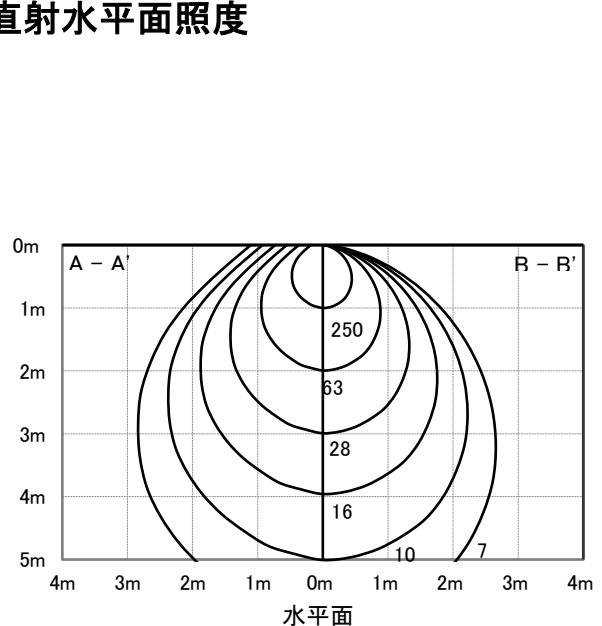

ECOHiLUX照明器具 配光データシート

意匠図

器具品名	直管用専用器具 直付下面開放型20形1灯			保守率	
器具品番	IRLDL21UK			良	0.69
部品品名	直管LEDランプ HE190S			中	0.67
部品品番	LDG20T・WW/6/9/19SL/R			否	0.63
器具光束	894lm	最大取付間隔		上方向	0%
光源	-	AA		下方向	99%
光源光束	900lm	BB		全方向	99%

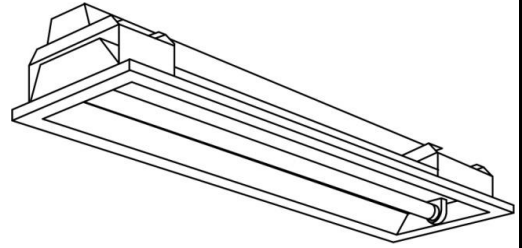

照明率表

作業面照明率(×0.01)

反天井 %射率	80								70								50				30				0	
	70	50	30	10	70	50	30	10	70	50	30	10	50	30	10	30	10	0	30	10	0					
0.4	45	42	31	30	24	23	19	44	41	31	30	24	23	19	30	29	23	23	19	23	23	19	17			
0.6	62	57	47	45	38	37	32	60	56	47	44	38	37	32	45	43	37	37	32	37	36	32	30			
0.8	72	66	57	54	48	46	40	70	64	56	53	47	45	40	54	52	46	45	39	45	44	39	37			
1	81	73	67	62	57	54	48	78	71	65	61	56	53	48	63	59	55	53	47	53	52	47	45			
1.3	90	80	76	70	66	62	56	87	78	74	69	65	62	56	71	67	63	61	56	62	60	55	53			
1.5	95	84	82	75	73	67	62	92	82	80	74	71	67	61	76	72	69	66	61	67	65	60	58			
2	103	90	92	82	83	76	71	99	88	89	81	81	75	70	85	79	78	74	69	75	72	69	66			
2.5	108	94	99	87	91	82	77	105	92	96	86	89	81	77	91	84	85	80	76	82	78	75	72			
3	112	96	103	91	96	86	81	108	94	100	89	94	85	81	95	87	89	83	80	86	82	79	76			
4	117	99	110	95	104	91	88	112	98	106	94	101	90	87	100	92	96	88	86	91	87	84	82			
5	120	101	114	98	109	95	92	115	100	110	97	105	94	91	103	94	100	92	89	95	90	88	85			
7	123	103	119	101	115	99	96	119	102	115	100	111	98	95	107	98	105	96	94	99	94	92	89			
10	126	105	123	103	120	102	100	121	104	118	102	116	101	99	111	100	109	99	97	102	97	96	93			

配光曲線

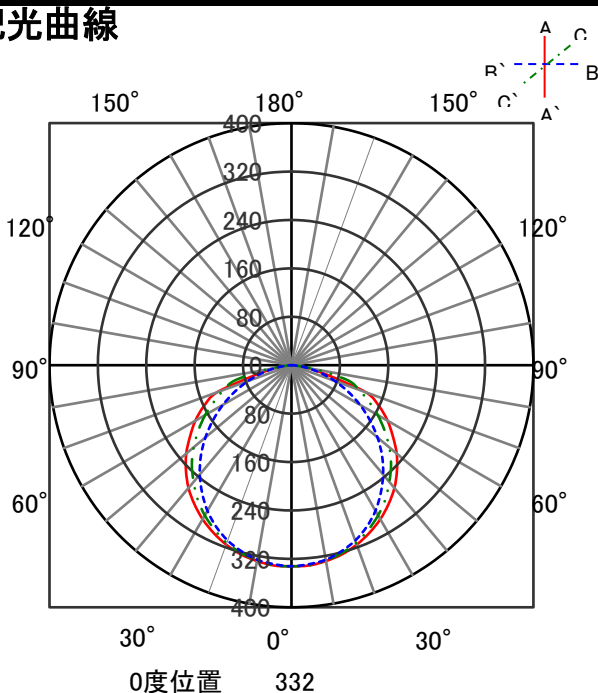

直射水平面照度

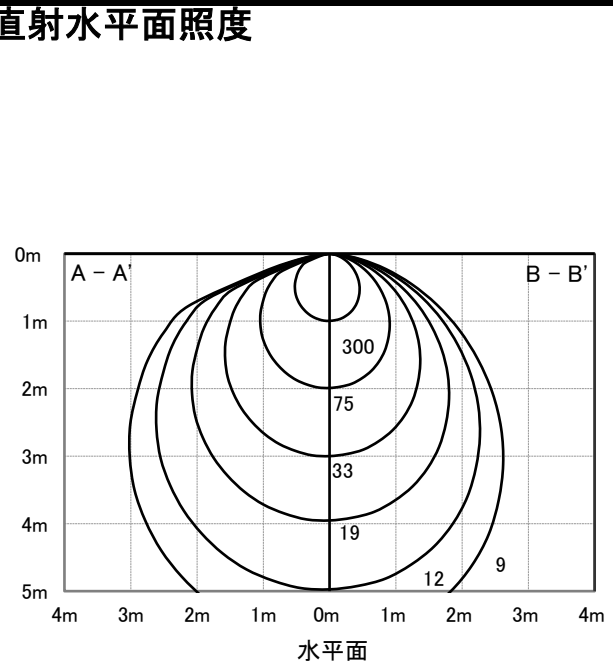

ECOHiLUX照明器具 配光データシート

意匠図

器具品名	直管用専用器具 直付下面開放型20形2灯			保守率	
器具品番	IRLDFL22CL			良	0.69
部品品名	直管LEDランプ° HE190S			中	0.67
部品品番	LDG20T・WW/6/9/19SL/R			否	0.63
器具光束	1685lm	最大取付間隔		器具効率	
光源	LED	AA		上方向	0%
光源光束	900lm × 2	BB		下方向	94%
				全方向	94%

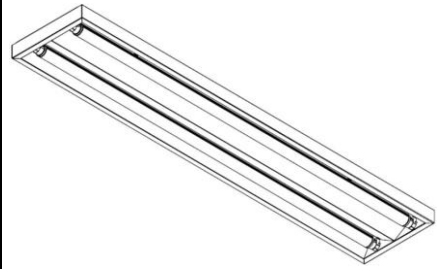

照明率表

作業面照明率(×0.01)

反(天井)	80								70								50				30		0		
	壁	70		50		30		10		70		50		30		10		50		30		10		0	
床	30	10	30	10	30	10	30	10	30	10	30	10	30	10	30	10	30	10	30	10	30	10	30	10	0
室 指 数	0.4	45	42	32	31	24	24	19	44	41	31	30	24	24	19	30	29	24	23	19	23	23	19	17	
	0.6	63	58	48	46	39	38	33	61	56	47	45	39	38	33	46	44	38	37	33	37	37	32	30	
	0.8	73	66	58	55	49	47	41	71	65	57	54	48	46	41	55	52	47	46	41	46	45	40	38	
	1	82	74	68	63	58	55	49	79	72	66	62	57	55	49	64	60	56	54	49	54	53	48	46	
	1.3	91	80	77	71	68	64	58	88	79	76	70	67	63	58	72	68	65	62	57	63	61	57	54	
	1.5	96	84	83	76	74	69	63	93	83	81	75	73	68	63	77	73	70	67	62	68	66	62	59	
	2	104	90	93	83	84	77	72	100	89	90	82	83	76	72	86	80	79	75	71	76	73	70	67	
	2.5	109	94	100	88	92	83	79	105	92	97	87	90	82	78	91	85	86	80	77	82	79	76	73	
	3	112	96	104	91	97	87	83	108	95	101	90	95	86	82	95	88	90	84	81	86	82	80	77	
	4	117	100	110	95	104	92	88	113	98	107	94	101	91	88	100	92	96	89	86	91	87	85	82	
5	120	101	114	98	109	95	92	115	100	110	97	106	94	91	103	94	100	92	90	95	90	88	85		
7	123	103	119	101	115	99	97	118	102	115	100	111	98	96	107	97	105	95	94	99	93	92	89		
10	126	105	122	103	120	102	100	121	104	118	102	116	100	99	110	99	108	98	97	102	96	95	92		

配光曲線

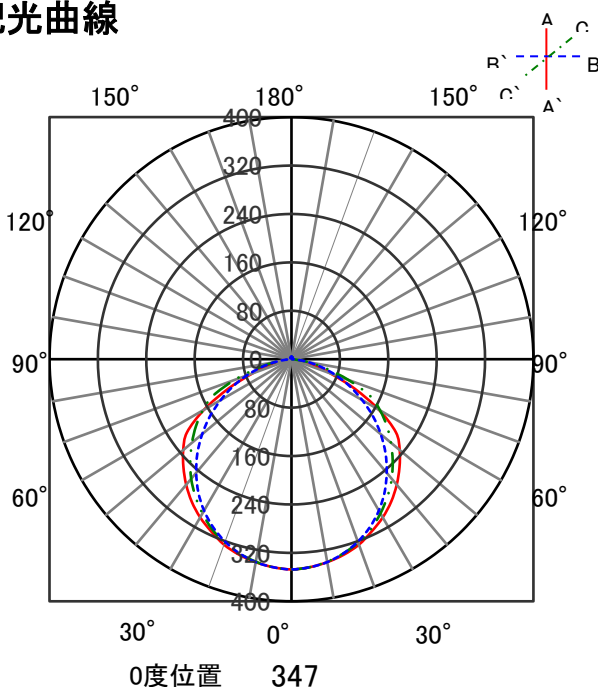

直射水平面照度

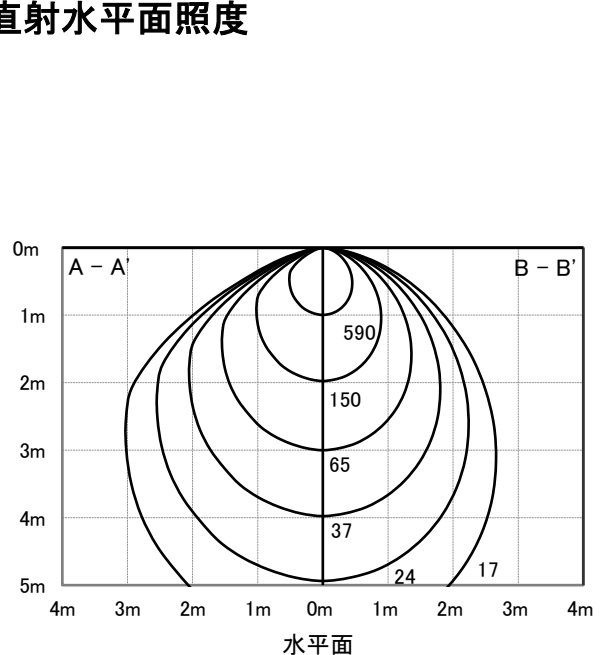

ECOHiLUX照明器具 配光データシート

意匠図

器具品名	直管用専用器具 逆富士型20形2灯			保守率	
器具品番	IRLDL22FJ			良	0.69
部品品名	直管LEDランプ° HE190S			中	0.67
部品品番	LDG20T・WW/6/9/19SL/R			否	0.63
器具光束	1694lm	最大取付間隔		器具効率	
光源	LED	AA		上方向	4%
光源光束	900lm × 2	BB		下方向	90%
				全方向	94%

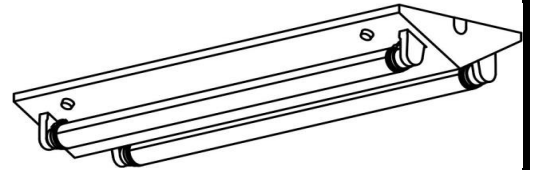

照明率表

作業面照明率(×0.01)

反天井 %射率	80								70								50				30		0	
	壁	70	50	30	10	70	50	30	10	70	50	30	10	50	30	10	30	10	0	0				
床	30	10	30	10	30	10	30	10	30	10	30	10	30	10	30	10	30	10	30	10	0	0		
室 指 数	0.4	44	41	31	30	23	23	18	43	40	30	29	23	22	18	29	28	22	22	18	22	21	17	16
	0.6	61	56	46	44	37	36	31	58	54	45	43	37	36	30	43	41	35	35	30	34	34	29	27
	0.8	71	64	56	52	46	44	38	68	62	54	51	45	44	38	52	49	44	42	37	42	41	37	34
	1	79	71	65	60	55	52	46	76	69	63	59	54	51	46	59	56	52	50	45	50	48	44	41
	1.3	87	78	74	68	64	60	54	84	76	72	66	63	59	54	68	64	60	57	53	58	56	51	48
	1.5	93	82	80	72	70	65	59	89	79	77	71	68	64	59	73	68	65	62	57	62	60	56	53
	2	100	87	89	80	80	73	68	96	85	86	78	78	72	67	81	75	74	70	65	70	68	64	60
	2.5	106	91	96	85	88	79	74	101	89	92	83	85	78	73	86	80	80	75	71	76	73	69	66
	3	109	94	100	88	93	83	78	105	92	97	86	90	81	77	90	83	85	79	75	80	76	73	69
	4	114	97	107	92	100	88	84	109	95	102	90	97	87	83	95	87	91	84	81	85	81	78	74
5	117	99	111	95	105	91	88	112	97	106	93	101	90	87	98	90	95	87	84	88	84	82	78	
7	120	101	116	98	111	96	93	115	99	111	96	107	94	92	102	93	99	91	89	93	88	86	82	
10	123	103	120	101	116	99	97	118	101	115	99	112	97	95	106	95	103	94	92	96	91	89	85	

配光曲線

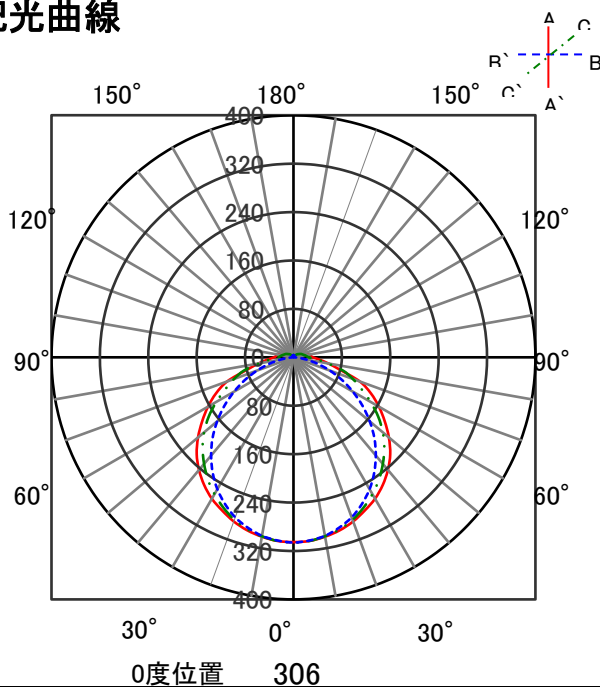

直射水平面照度

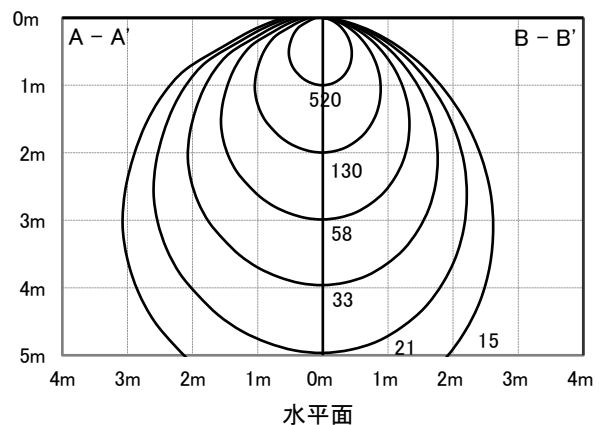

ECOHiLUX照明器具 配光データシート

意匠図

器具品名	直管用専用器具 トラフ型20形2灯			保守率	
器具品番	IRLDL22TR			良	0.69
部品品名	直管LEDランプ° HE190S			中	0.67
部品品番	LDG20T・WW/6/9/19SL/R			否	0.63
器具光束	1656lm	最大取付間隔		器具効率	
光源	LED	AA		上方向	8%
光源光束	900lm × 2	BB		下方向	84%
				全方向	92%

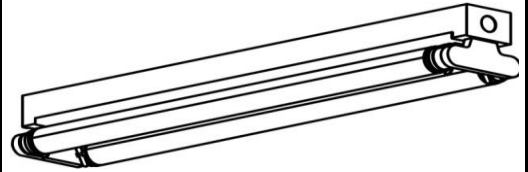

照明率表

作業面照明率(×0.01)

反天井 %射率	80								70								50				30				0	
	壁		70		50		30		10		70		50		30		10		50		30		10		0	
床	30	10	30	10	30	10	30	10	30	10	30	10	30	10	30	10	30	10	30	10	30	10	30	10	0	0
室 指 数	0.4	60	55	45	43	36	35	30	58	53	44	42	36	35	30	42	40	34	34	29	33	33	28	26	0	0
	0.6	70	64	55	52	45	43	37	67	61	53	50	44	43	37	50	48	42	41	36	41	40	35	32	0	0
	0.8	78	70	64	59	54	51	45	75	68	62	58	53	50	44	58	55	50	48	43	48	47	42	39	0	0
	1	86	77	73	67	63	59	53	83	74	70	65	61	58	52	66	62	58	56	51	56	54	50	46	0	0
	1.3	92	81	79	71	69	64	58	88	78	76	70	67	63	57	71	67	64	61	56	60	58	54	50	0	0
	1.5	99	87	88	79	79	72	66	95	84	85	77	76	71	65	79	73	72	68	64	68	66	62	58	0	0
	2	105	90	95	84	86	78	73	100	88	91	82	84	76	72	84	78	78	74	69	74	71	67	63	0	0
	2.5	108	93	99	87	91	82	77	103	90	95	85	88	80	76	88	81	83	77	73	78	74	71	67	0	0
	3	113	96	105	91	99	87	83	108	94	101	89	95	85	82	93	85	89	82	79	83	79	76	72	0	0
	4	116	98	110	94	104	90	87	111	96	105	92	100	89	85	97	88	93	85	83	86	82	80	75	0	0
5	119	100	115	97	110	95	92	114	98	110	95	106	93	90	101	91	98	89	87	90	86	84	79	0	0	
7	122	102	119	100	115	98	96	117	100	113	98	110	96	94	104	94	102	92	91	94	89	87	82	0	0	
10	0	0	0	0	0	0	0	0	0	0	0	0	0	0	0	0	0	0	0	0	0	0	0	0	0	

配光曲線

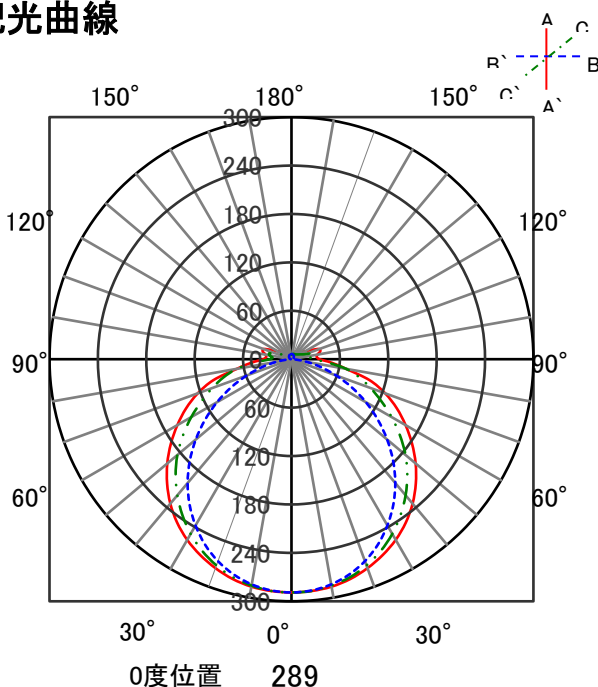

直射水平面照度

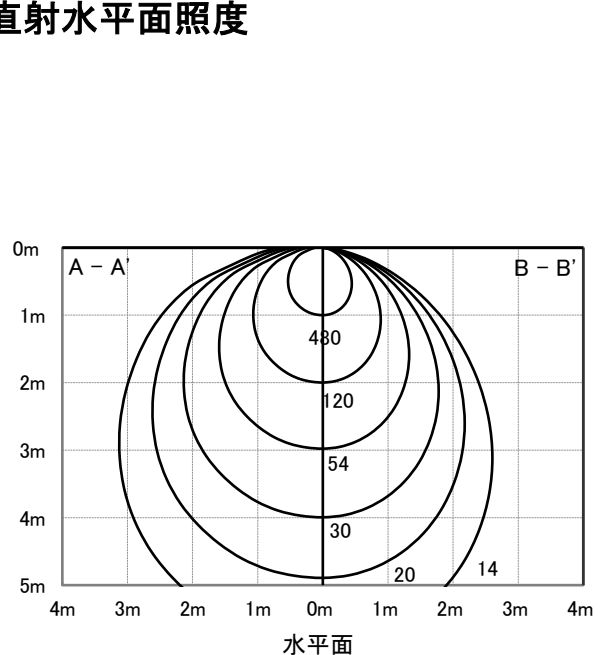

ECOHiLUX照明器具 配光データシート

意匠図

器具品名	直管用専用器具 直付下面開放型20形2灯			保守率	
器具品番	IRLDL22UK			良	0.69
部品品名	直管LEDランプ° HE190S			中	0.67
部品品番	LDG20T・WW/6/9/19SL/R			否	0.63
器具光束	1787lm	最大取付間隔		器具効率	
光源	-	AA		上方向	0%
光源光束	900lm × 2	BB		下方向	99%
				全方向	99%

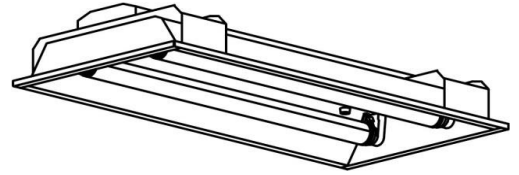

照明率表

作業面照明率(×0.01)

反天井 (%射率)	80								70								50				30		0	
	壁	70	50	30	10	70	50	30	10	70	50	30	10	50	30	10	30	10	0	0				
床	30	10	30	10	30	10	10	30	10	30	10	30	10	30	10	30	10	10	30	10	0	0		
室 指 数	0.4	45	43	32	31	24	24	19	44	42	31	30	24	24	19	30	30	24	23	19	23	23	19	18
	0.6	63	58	48	46	40	39	33	61	57	48	46	39	38	33	46	44	39	38	33	38	37	33	31
	0.8	74	67	59	56	50	48	42	72	66	58	55	49	47	42	56	53	48	47	42	47	46	41	39
	1	83	74	69	64	59	56	50	80	73	67	63	58	56	50	65	61	57	55	50	56	54	50	47
	1.3	92	81	78	72	69	65	59	89	80	77	71	68	64	59	74	69	66	63	59	64	63	58	56
	1.5	97	85	85	77	75	70	65	94	84	83	76	74	70	64	79	74	72	68	64	70	67	63	61
	2	105	91	94	84	86	78	73	101	90	92	83	84	78	73	87	81	81	76	72	78	75	72	69
	2.5	110	95	101	89	93	84	80	106	93	98	88	91	83	79	93	86	87	82	78	84	81	77	75
	3	113	97	105	92	98	88	84	109	96	102	91	96	87	83	97	89	92	85	82	88	84	81	79
	4	118	100	111	96	105	93	89	113	99	108	95	103	92	89	101	93	97	90	87	93	88	86	84
5	120	102	115	99	110	96	93	116	101	111	98	107	95	92	105	95	101	93	91	96	91	89	87	
7	124	104	119	102	116	99	97	119	103	115	100	112	98	96	108	98	106	96	95	100	95	93	90	
10	126	105	123	104	120	102	101	121	104	119	103	116	101	100	111	100	109	99	98	103	97	96	93	

配光曲線

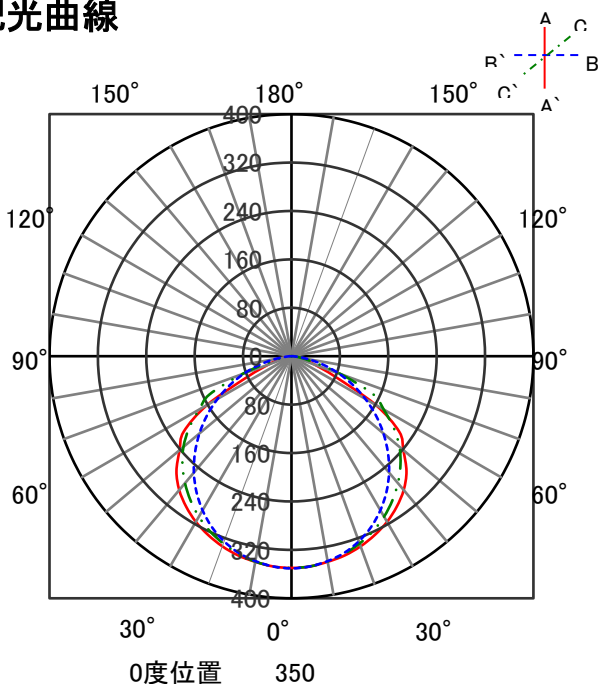

直射水平面照度

