

ECOHiLUX照明器具 配光データシート

意匠図

器具品名	直管型LEDランプ 専用器具 逆富士型	保守率	
器具品番	IRLDFL22FJ	良	0.81
部品品名	-	中	0.77
部品品番	-	否	0.67
		器具効率	
器具光束	1880lm	上方向	4%
光源	LDG20S・WW/8/10	下方向	90%
光源光束	1000lm × 2	全方向	94%

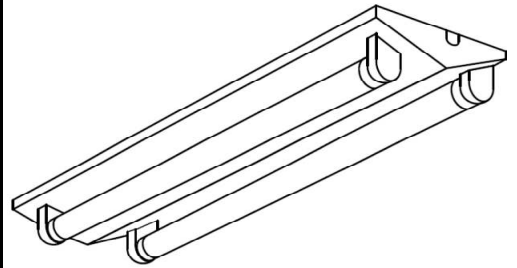

照明率表

反射率	天井 壁	80								70				50				30		0					
		70	10	30	10	30	10	10	10	70	10	30	10	30	10	10	10	50	10	30	10	10	10	30	10
室 指 数	0.4	40	38	28	27	20	20	16	39	37	27	26	20	20	16	26	25	20	20	16	20	19	15	14	
	0.6	55	51	42	39	33	32	27	54	50	41	39	33	32	27	39	38	32	31	27	31	31	27	25	
	0.8	65	59	50	47	41	39	34	63	57	49	47	41	39	34	47	45	40	38	33	39	38	33	31	
	1	73	65	59	54	49	47	41	70	64	57	53	48	46	41	55	52	47	45	40	46	44	40	38	
	1.25	80	71	67	61	58	54	48	77	70	65	60	57	53	48	62	59	55	52	47	53	51	47	45	
	1.5	85	75	73	66	63	59	53	82	73	71	65	62	58	53	67	63	60	57	52	58	56	51	49	
	2	92	80	81	73	72	66	61	89	79	79	71	71	65	60	75	69	68	64	59	65	63	59	56	
	2.5	98	84	88	77	79	72	67	94	82	85	76	78	71	66	80	74	74	69	65	71	68	64	62	
	3	101	86	92	80	84	75	71	97	85	89	79	82	74	70	84	77	78	73	69	74	71	68	65	
	4	105	90	98	85	91	80	76	101	88	95	83	89	79	76	89	81	84	78	74	80	76	73	70	
5	108	92	102	87	96	84	80	104	90	98	86	93	83	79	92	84	88	81	78	83	79	77	74		
7	112	94	107	91	102	88	85	107	92	103	89	99	87	84	96	87	93	85	83	87	83	81	78		
10	114	96	111	93	107	91	89	110	94	107	92	103	90	88	99	90	97	88	86	91	86	84	82		

配光曲線

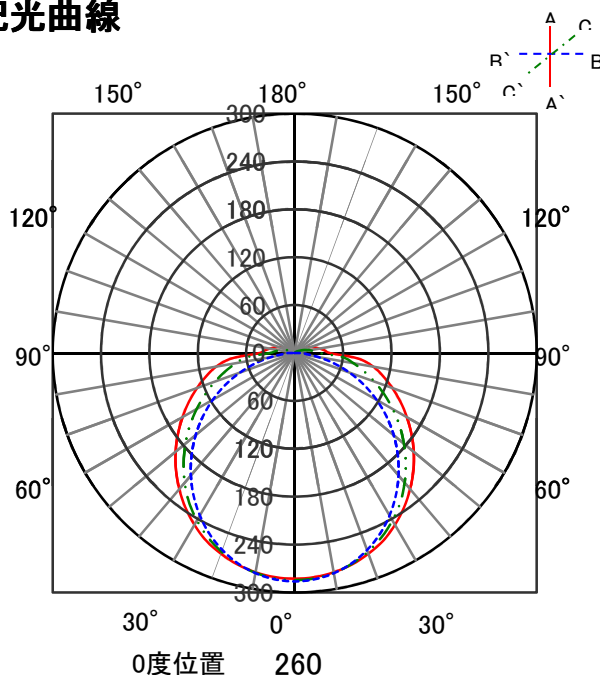

直射水平面照度

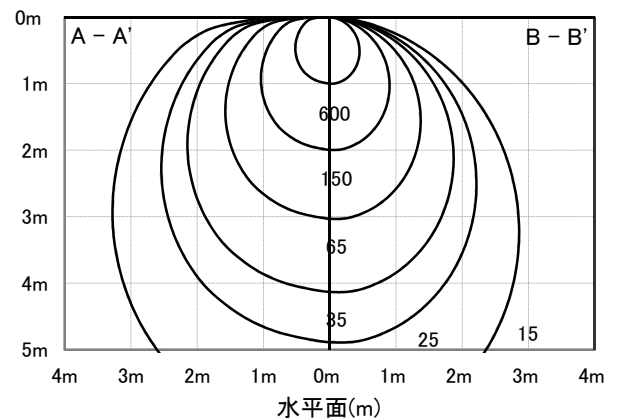

ECOHiLUX照明器具 配光データシート

意匠図

器具品名	直管型LEDランプ 専用器具 逆富士型	保守率	
器具品番	IRLDFL22FJ	良	0.81
部品品名	-	中	0.77
部品品番	-	否	0.67
器具光束	1880lm	器具効率	
光源	LDG20S・W/7/10	上方向	4%
光源光束	1000lm × 2	下方向	90%
		全方向	94%

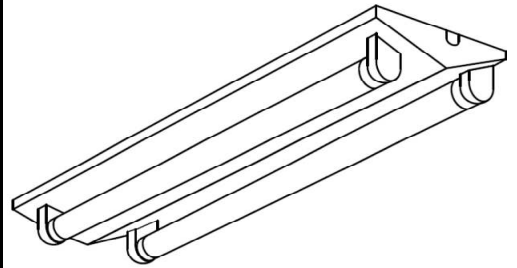

照明率表

反射率	天井 壁	80								70				50				30				0							
		70	10	30	10	30	10	10	10	70	10	30	10	30	10	10	10	50	10	30	10	10	10	30	10	10	0	30	10
室 指 数	0.4	40	38	28	27	20	20	16	39	37	27	26	20	20	16	26	25	20	20	16	20	19	15	14					
	0.6	55	51	42	39	33	32	27	54	50	41	39	33	32	27	39	38	32	31	27	31	31	27	25					
	0.8	65	59	50	47	41	39	34	63	57	49	47	41	39	34	47	45	40	38	33	39	38	33	31					
	1	73	65	59	54	49	47	41	70	64	57	53	48	46	41	55	52	47	45	40	46	44	40	38					
	1.25	80	71	67	61	58	54	48	77	70	65	60	57	53	48	62	59	55	52	47	53	51	47	45					
	1.5	85	75	73	66	63	59	53	82	73	71	65	62	58	53	67	63	60	57	52	58	56	51	49					
	2	92	80	81	73	72	66	61	89	79	79	71	71	65	60	75	69	68	64	59	65	63	59	56					
	2.5	98	84	88	77	79	72	67	94	82	85	76	78	71	66	80	74	74	69	65	71	68	64	62					
	3	101	86	92	80	84	75	71	97	85	89	79	82	74	70	84	77	78	73	69	74	71	68	65					
	4	105	90	98	85	91	80	76	101	88	95	83	89	79	76	89	81	84	78	74	80	76	73	70					
5	108	92	102	87	96	84	80	104	90	98	86	93	83	79	92	84	88	81	78	83	79	77	74						
7	112	94	107	91	102	88	85	107	92	103	89	99	87	84	96	87	93	85	83	87	83	81	78						
10	114	96	111	93	107	91	89	110	94	107	92	103	90	88	99	90	97	88	86	91	86	84	82						

配光曲線

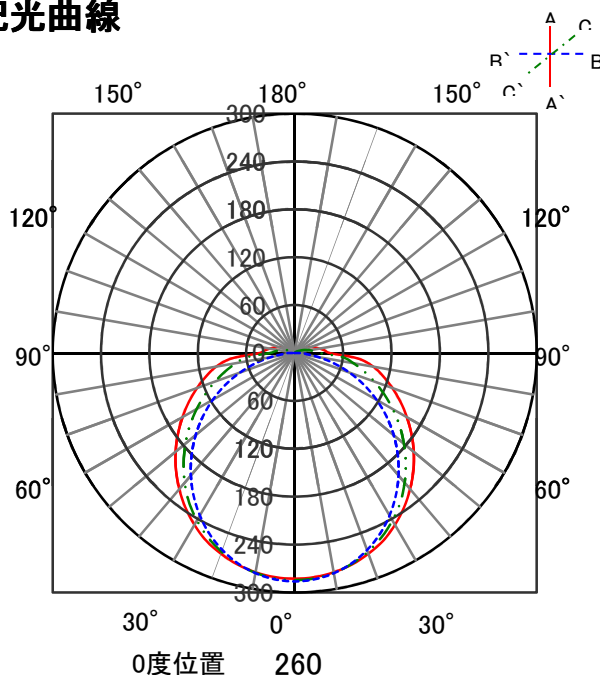

直射水平面照度

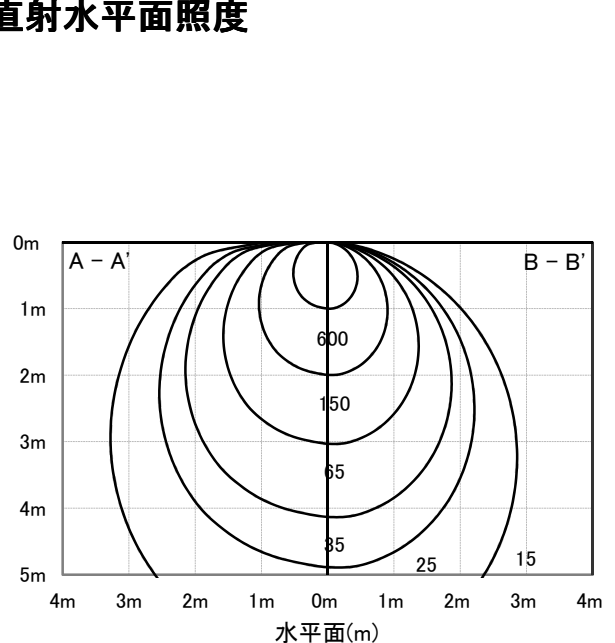

ECOHiLUX照明器具 配光データシート

意匠図

器具品名	直管型LEDランプ 専用器具 逆富士型	保守率	
器具品番	IRLDFL22FJ	良	0.81
部品品名	-	中	0.77
部品品番	-	否	0.67
器具光束	1880lm	器具効率	
光源	LDG20S・D/7/10	上方向	4%
光源光束	1000lm × 2	下方向	90%
		全方向	94%

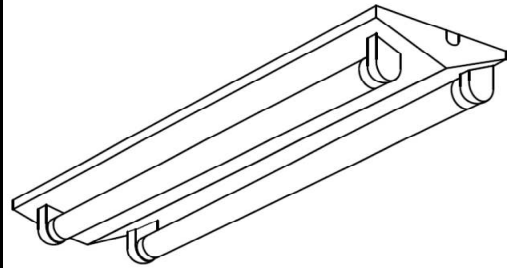

照明率表

反射率	天井 壁	80								70				50				30		0					
		70	10	30	10	30	10	10	10	70	10	30	10	30	10	10	10	50	30	10	30	10	10	30	10
室 指 数	0.4	40	38	28	27	20	20	16	39	37	27	26	20	20	16	26	25	20	20	16	20	19	15	14	
	0.6	55	51	42	39	33	32	27	54	50	41	39	33	32	27	39	38	32	31	27	31	31	27	25	
	0.8	65	59	50	47	41	39	34	63	57	49	47	41	39	34	47	45	40	38	33	39	38	33	31	
	1	73	65	59	54	49	47	41	70	64	57	53	48	46	41	55	52	47	45	40	46	44	40	38	
	1.25	80	71	67	61	58	54	48	77	70	65	60	57	53	48	62	59	55	52	47	53	51	47	45	
	1.5	85	75	73	66	63	59	53	82	73	71	65	62	58	53	67	63	60	57	52	58	56	51	49	
	2	92	80	81	73	72	66	61	89	79	79	71	71	65	60	75	69	68	64	59	65	63	59	56	
	2.5	98	84	88	77	79	72	67	94	82	85	76	78	71	66	80	74	74	69	65	71	68	64	62	
	3	101	86	92	80	84	75	71	97	85	89	79	82	74	70	84	77	78	73	69	74	71	68	65	
	4	105	90	98	85	91	80	76	101	88	95	83	89	79	76	89	81	84	78	74	80	76	73	70	
5	108	92	102	87	96	84	80	104	90	98	86	93	83	79	92	84	88	81	78	83	79	77	74		
7	112	94	107	91	102	88	85	107	92	103	89	99	87	84	96	87	93	85	83	87	83	81	78		
10	114	96	111	93	107	91	89	110	94	107	92	103	90	88	99	90	97	88	86	91	86	84	82		

配光曲線

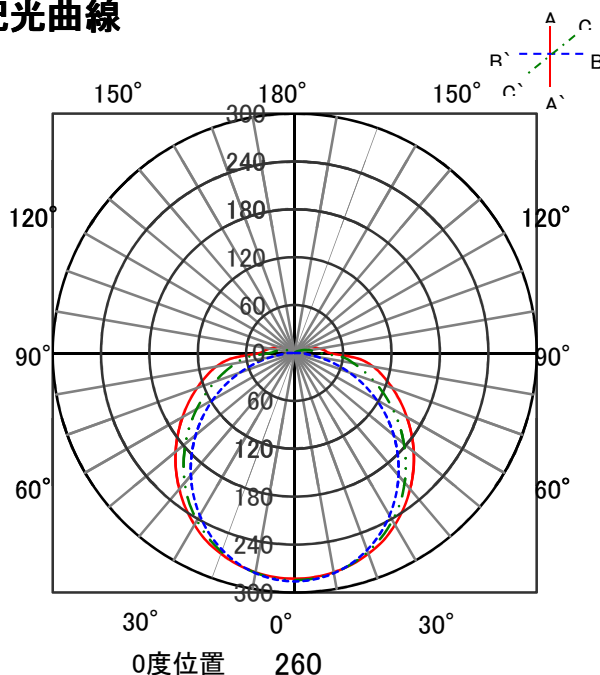

直射水平面照度

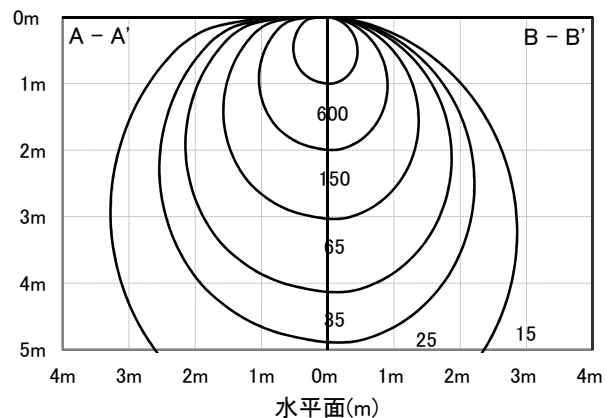

ECOHiLUX照明器具 配光データシート

意匠図

器具品名	直管型LEDランプ 専用器具 逆富士型	保守率	
器具品番	IRLDFL22FJ	良	0.81
部品品名	-	中	0.77
部品品番	-	否	0.67
		器具効率	
器具光束	1880lm	上方向	4%
光源	LDGR20S・WW/9/10	下方向	90%
光源光束	1000lm × 2	全方向	94%

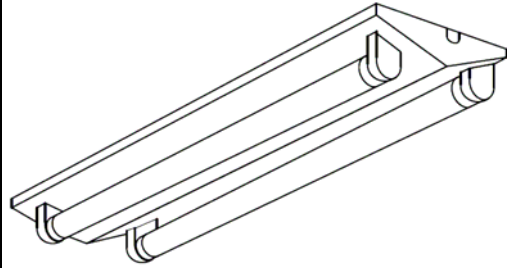

照明率表

反射率	天井 壁	80								70				50				30		0					
		70	10	30	10	30	10	10	10	70	10	30	10	30	10	10	10	50	10	30	10	10	10	30	10
室 指 数	0.4	40	38	28	27	20	20	16	39	37	27	26	20	20	16	26	25	20	20	16	20	19	15	14	
	0.6	55	51	42	39	33	32	27	54	50	41	39	33	32	27	39	38	32	31	27	31	31	27	25	
	0.8	65	59	50	47	41	39	34	63	57	49	47	41	39	34	47	45	40	38	33	39	38	33	31	
	1	73	65	59	54	49	47	41	70	64	57	53	48	46	41	55	52	47	45	40	46	44	40	38	
	1.25	80	71	67	61	58	54	48	77	70	65	60	57	53	48	62	59	55	52	47	53	51	47	45	
	1.5	85	75	73	66	63	59	53	82	73	71	65	62	58	53	67	63	60	57	52	58	56	51	49	
	2	92	80	81	73	72	66	61	89	79	79	71	71	65	60	75	69	68	64	59	65	63	59	56	
	2.5	98	84	88	77	79	72	67	94	82	85	76	78	71	66	80	74	74	69	65	71	68	64	62	
	3	101	86	92	80	84	75	71	97	85	89	79	82	74	70	84	77	78	73	69	74	71	68	65	
	4	105	90	98	85	91	80	76	101	88	95	83	89	79	76	89	81	84	78	74	80	76	73	70	
5	108	92	102	87	96	84	80	104	90	98	86	93	83	79	92	84	88	81	78	83	79	77	74		
7	112	94	107	91	102	88	85	107	92	103	89	99	87	84	96	87	93	85	83	87	83	81	78		
10	114	96	111	93	107	91	89	110	94	107	92	103	90	88	99	90	97	88	86	91	86	84	82		

配光曲線

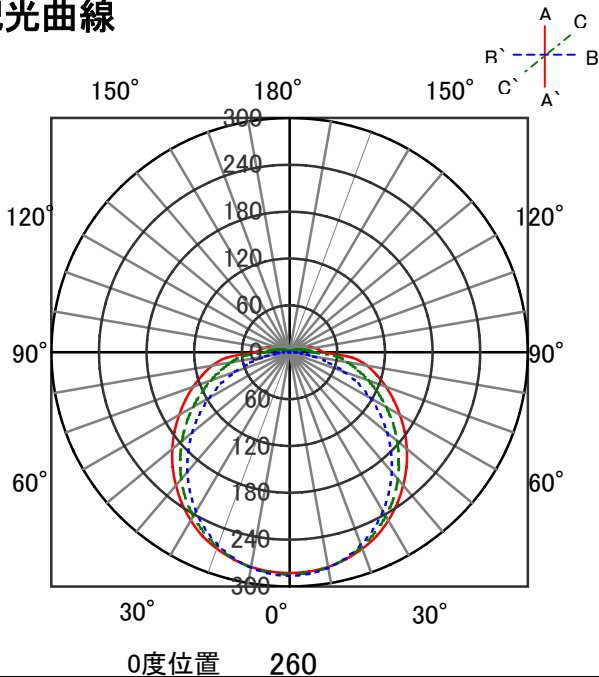

直射水平面照度

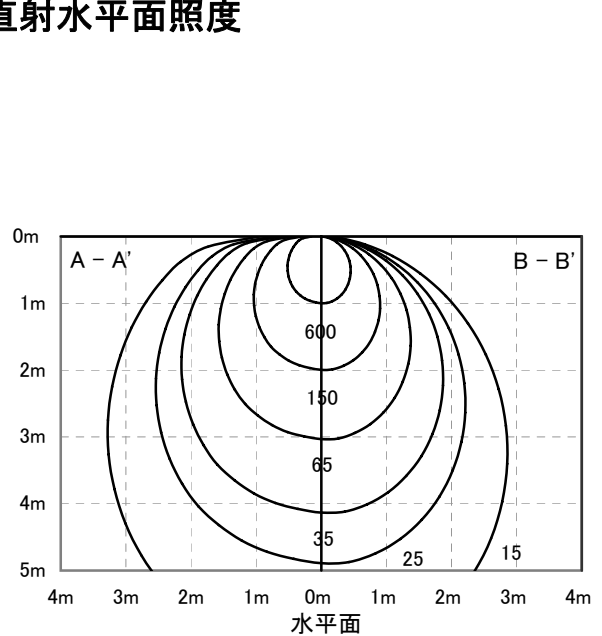

ECOHiLUX照明器具 配光データシート

意匠図

器具品名	直管型LEDランプ 専用器具 逆富士型	保守率	
器具品番	IRLDFL22FJ	良	0.81
部品品名	-	中	0.77
部品品番	-	否	0.67
器具光束	1880lm	器具効率	
光源	LDGR20S・W/8/10	上方向	4%
光源光束	1000lm × 2	下方向	90%
		全方向	94%

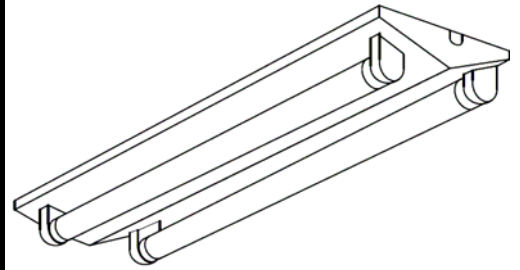

照明率表

		作業面照明率(×0.01)																							
反射率	天井	80								70				50				30		0					
	壁	70	10	30	10	30	10	10	10	70	10	30	10	30	10	10	30	10	30	10	10	30	10	10	0
室 指 数	0.4	40	38	28	27	20	20	16	39	37	27	26	20	20	16	26	25	20	20	16	20	19	15	14	
	0.6	55	51	42	39	33	32	27	54	50	41	39	33	32	27	39	38	32	31	27	31	31	27	25	
	0.8	65	59	50	47	41	39	34	63	57	49	47	41	39	34	47	45	40	38	33	39	38	33	31	
	1	73	65	59	54	49	47	41	70	64	57	53	48	46	41	55	52	47	45	40	46	44	40	38	
	1.25	80	71	67	61	58	54	48	77	70	65	60	57	53	48	62	59	55	52	47	53	51	47	45	
	1.5	85	75	73	66	63	59	53	82	73	71	65	62	58	53	67	63	60	57	52	58	56	51	49	
	2	92	80	81	73	72	66	61	89	79	79	71	71	65	60	75	69	68	64	59	65	63	59	56	
	2.5	98	84	88	77	79	72	67	94	82	85	76	78	71	66	80	74	74	69	65	71	68	64	62	
	3	101	86	92	80	84	75	71	97	85	89	79	82	74	70	84	77	78	73	69	74	71	68	65	
	4	105	90	98	85	91	80	76	101	88	95	83	89	79	76	89	81	84	78	74	80	76	73	70	
5	108	92	102	87	96	84	80	104	90	98	86	93	83	79	92	84	88	81	78	83	79	77	74		
7	112	94	107	91	102	88	85	107	92	103	89	99	87	84	96	87	93	85	83	87	83	81	78		
10	114	96	111	93	107	91	89	110	94	107	92	103	90	88	99	90	97	88	86	91	86	84	82		

配光曲線

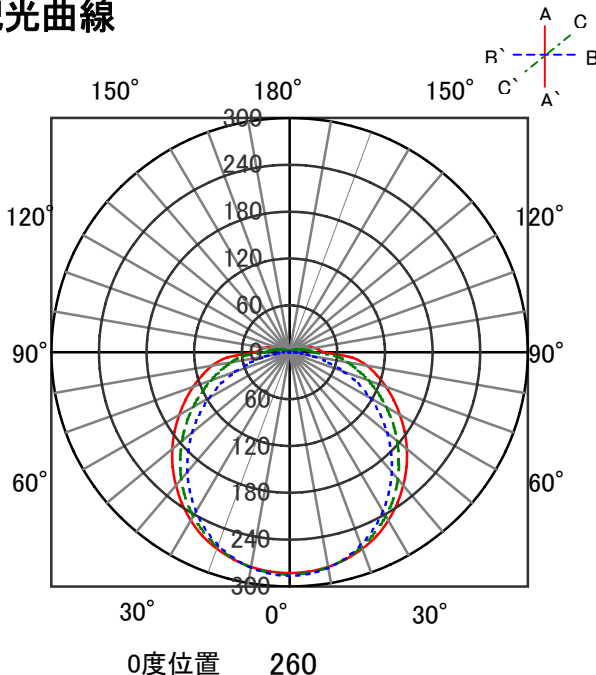

直射水平面照度

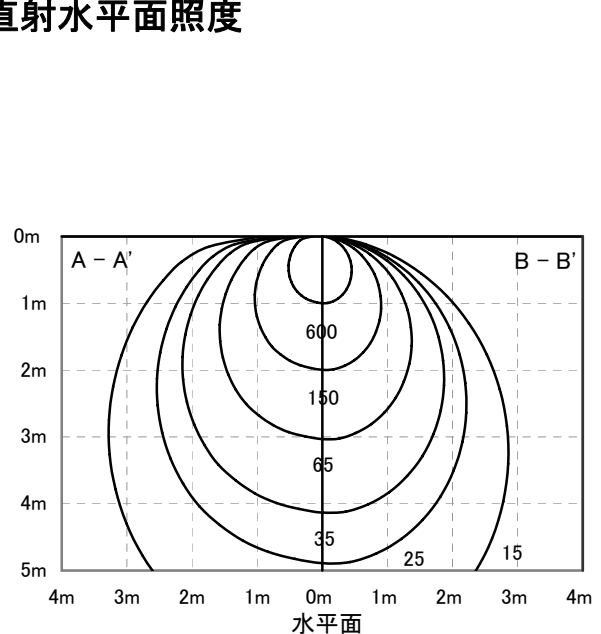

ECOHiLUX照明器具 配光データシート

意匠図

器具品名	直管型LEDランプ 専用器具 逆富士型	保守率	
器具品番	IRLDFL22FJ	良	0.81
部品品名	-	中	0.77
部品品番	-	否	0.67
		器具効率	
器具光束	1880lm	上方向	4%
光源	LDGR20S・N/8/10	下方向	90%
光源光束	1000lm × 2	全方向	94%

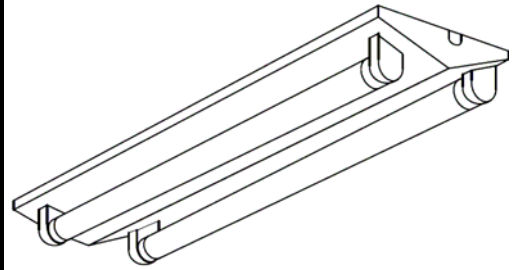

照明率表

		作業面照明率(×0.01)																							
反射率	天井	80								70				50				30		0					
	壁	70	50	30	10	70	50	30	10	50	30	10	30	10	0	30	10	0	0	0					
	床	30	10	30	10	30	10	10	30	10	30	10	30	10	10	30	10	30	10	10	30	10	10	0	0
室 指 数	0.4	40	38	28	27	20	20	16	39	37	27	26	20	20	16	26	25	20	20	16	20	19	15	14	14
	0.6	55	51	42	39	33	32	27	54	50	41	39	33	32	27	39	38	32	31	27	31	31	27	25	
	0.8	65	59	50	47	41	39	34	63	57	49	47	41	39	34	47	45	40	38	33	39	38	33	31	
	1	73	65	59	54	49	47	41	70	64	57	53	48	46	41	55	52	47	45	40	46	44	40	38	
	1.25	80	71	67	61	58	54	48	77	70	65	60	57	53	48	62	59	55	52	47	53	51	47	45	
	1.5	85	75	73	66	63	59	53	82	73	71	65	62	58	53	67	63	60	57	52	58	56	51	49	
	2	92	80	81	73	72	66	61	89	79	79	71	71	65	60	75	69	68	64	59	65	63	59	56	
	2.5	98	84	88	77	79	72	67	94	82	85	76	78	71	66	80	74	74	69	65	71	68	64	62	
	3	101	86	92	80	84	75	71	97	85	89	79	82	74	70	84	77	78	73	69	74	71	68	65	
	4	105	90	98	85	91	80	76	101	88	95	83	89	79	76	89	81	84	78	74	80	76	73	70	
5	108	92	102	87	96	84	80	104	90	98	86	93	83	79	92	84	88	81	78	83	79	77	74		
7	112	94	107	91	102	88	85	107	92	103	89	99	87	84	96	87	93	85	83	87	83	81	78		
10	114	96	111	93	107	91	89	110	94	107	92	103	90	88	99	90	97	88	86	91	86	84	82		

配光曲線

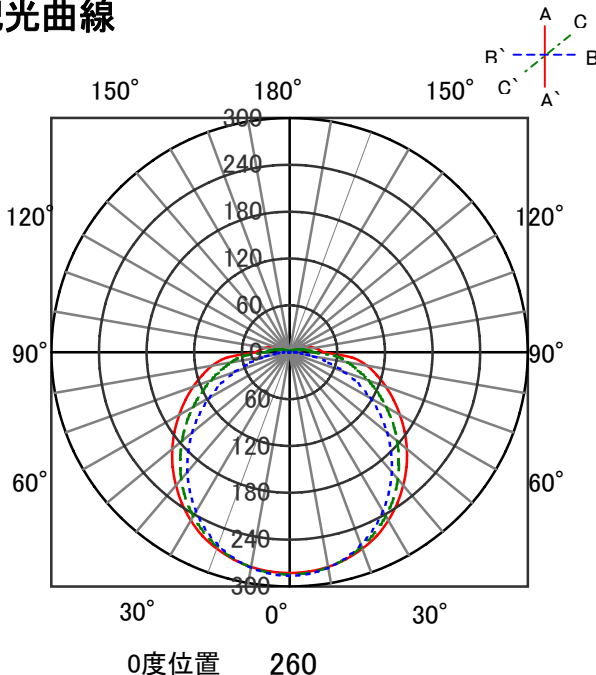

直射水平面照度

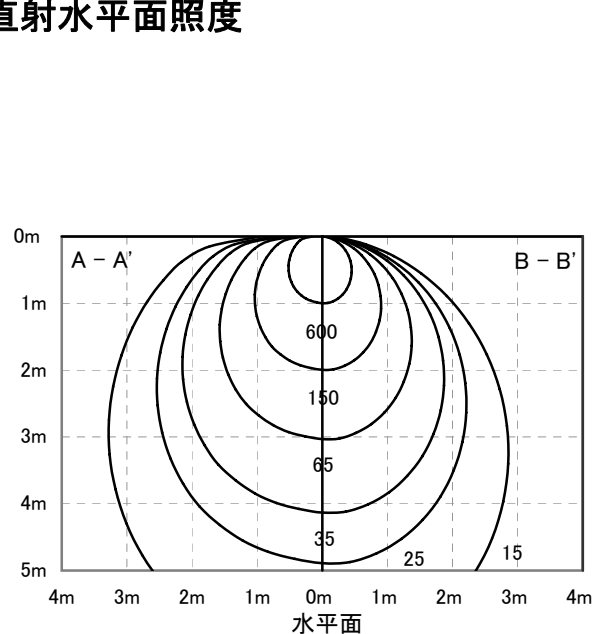

ECOHiLUX照明器具 配光データシート

意匠図

器具品名	直管型LEDランプ 専用器具 逆富士型	保守率	
器具品番	IRLDFL22FJ	良	0.81
部品品名	-	中	0.77
部品品番	-	否	0.67
		器具効率	
器具光束	1880lm	上方向	4%
光源	LDGR20S・D/8/10	下方向	90%
光源光束	1000lm × 2	全方向	94%

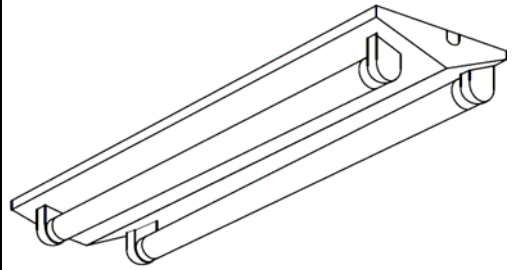

照明率表

		作業面照明率(×0.01)																						
反射率	天井 壁 床	80				70				50				30				0						
		70	50	30	10	70	50	30	10	50	30	10	10	30	10	10	30	10	10	0				
室 指 数	0.4	40	38	28	27	20	20	16	39	37	27	26	20	20	16	26	25	20	20	16	20	19	15	14
	0.6	55	51	42	39	33	32	27	54	50	41	39	33	32	27	39	38	32	31	27	31	31	27	25
	0.8	65	59	50	47	41	39	34	63	57	49	47	41	39	34	47	45	40	38	33	39	38	33	31
	1	73	65	59	54	49	47	41	70	64	57	53	48	46	41	55	52	47	45	40	46	44	40	38
	1.25	80	71	67	61	58	54	48	77	70	65	60	57	53	48	62	59	55	52	47	53	51	47	45
	1.5	85	75	73	66	63	59	53	82	73	71	65	62	58	53	67	63	60	57	52	58	56	51	49
	2	92	80	81	73	72	66	61	89	79	79	71	71	65	60	75	69	68	64	59	65	63	59	56
	2.5	98	84	88	77	79	72	67	94	82	85	76	78	71	66	80	74	74	69	65	71	68	64	62
	3	101	86	92	80	84	75	71	97	85	89	79	82	74	70	84	77	78	73	69	74	71	68	65
	4	105	90	98	85	91	80	76	101	88	95	83	89	79	76	89	81	84	78	74	80	76	73	70
5	108	92	102	87	96	84	80	104	90	98	86	93	83	79	92	84	88	81	78	83	79	77	74	
7	112	94	107	91	102	88	85	107	92	103	89	99	87	84	96	87	93	85	83	87	83	81	78	
10	114	96	111	93	107	91	89	110	94	107	92	103	90	88	99	90	97	88	86	91	86	84	82	

配光曲線

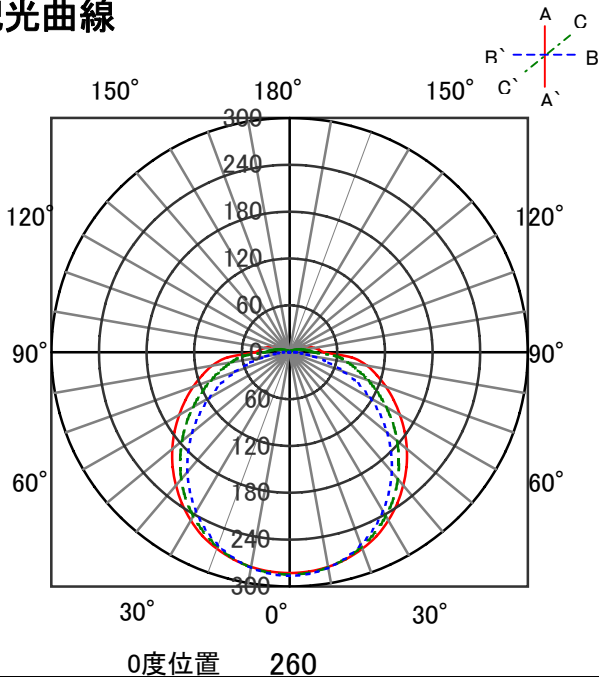

直射水平面照度

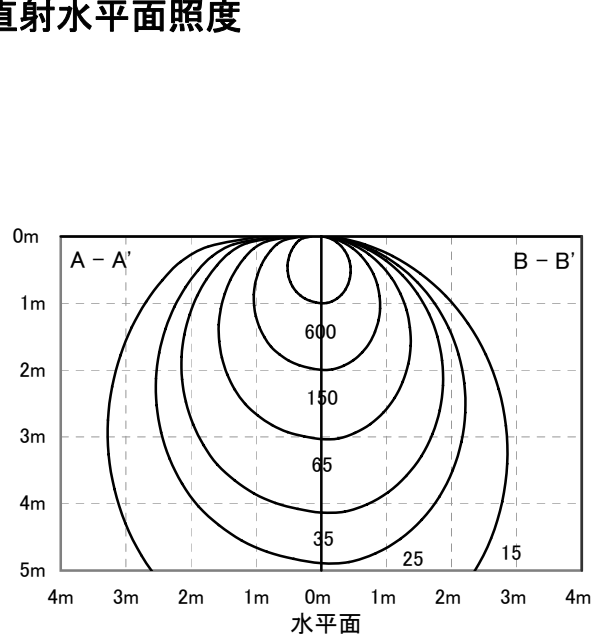

ECOHiLUX照明器具 配光データシート

意匠図

器具品名	直管型LEDランプ 専用器具 逆富士型	保守率	
器具品番	IRLDFL22FJ	良	0.81
部品品名	-	中	0.77
部品品番	-	否	0.67
		器具効率	
器具光束	1880lm	上方向	4%
光源	LDG20S・N/7/10	下方向	90%
光源光束	1000lm × 2	全方向	94%

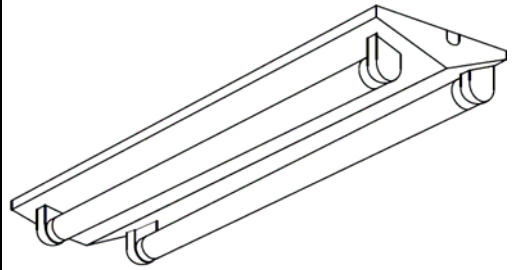

照明率表

		作業面照明率(×0.01)																						
反射率	天井	80								70				50				30		0				
	壁	70	50	30	10	70	50	30	10	70	50	30	10	50	30	10	30	10	30	10	0	0		
床	0.4	30	10	30	10	30	10	10	30	10	30	10	30	10	10	30	10	30	10	10	30	10	15	14
	0.6	55	51	42	39	33	32	27	54	50	41	39	33	32	27	39	38	32	31	27	31	31	27	25
	0.8	65	59	50	47	41	39	34	63	57	49	47	41	39	34	47	45	40	38	33	39	38	33	31
	1	73	65	59	54	49	47	41	70	64	57	53	48	46	41	55	52	47	45	40	46	44	40	38
	1.25	80	71	67	61	58	54	48	77	70	65	60	57	53	48	62	59	55	52	47	53	51	47	45
	1.5	85	75	73	66	63	59	53	82	73	71	65	62	58	53	67	63	60	57	52	58	56	51	49
	2	92	80	81	73	72	66	61	89	79	79	71	71	65	60	75	69	68	64	59	65	63	59	56
	2.5	98	84	88	77	79	72	67	94	82	85	76	78	71	66	80	74	74	69	65	71	68	64	62
	3	101	86	92	80	84	75	71	97	85	89	79	82	74	70	84	77	78	73	69	74	71	68	65
	4	105	90	98	85	91	80	76	101	88	95	83	89	79	76	89	81	84	78	74	80	76	73	70
	5	108	92	102	87	96	84	80	104	90	98	86	93	83	79	92	84	88	81	78	83	79	77	74
	7	112	94	107	91	102	88	85	107	92	103	89	99	87	84	96	87	93	85	83	87	83	81	78
	10	114	96	111	93	107	91	89	110	94	107	92	103	90	88	99	90	97	88	86	91	86	84	82

配光曲線

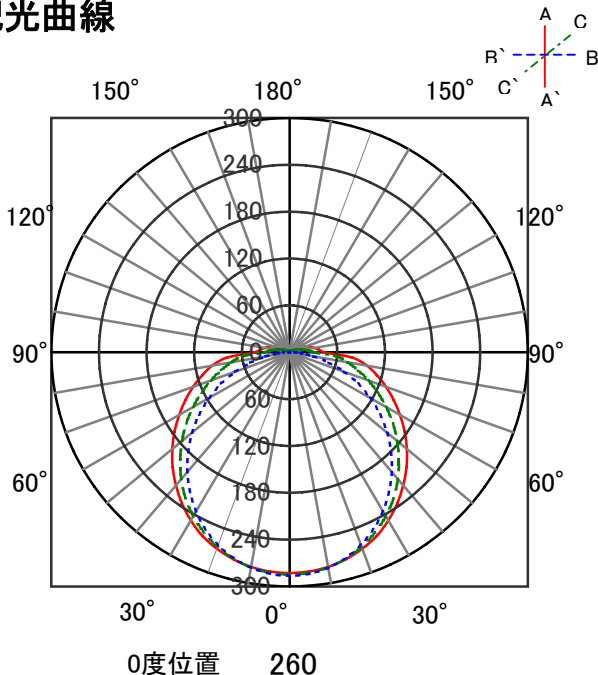

直射水平面照度

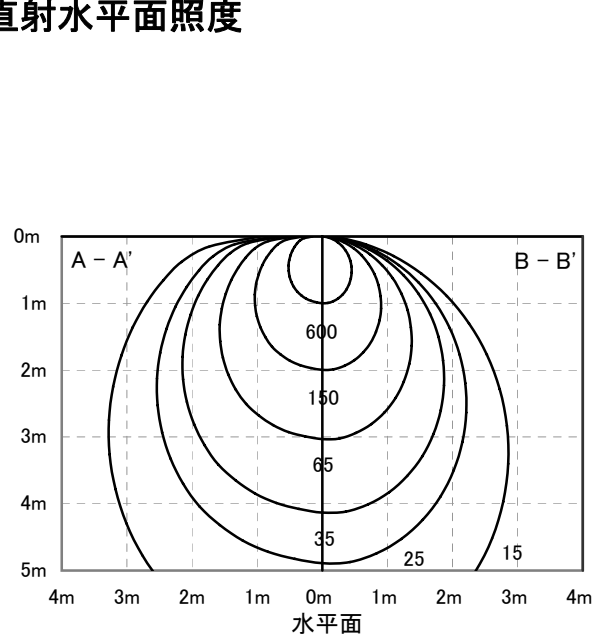

ECOHiLUX照明器具 配光データシート

意匠図

器具品名	直管形LEDランプ 専用器具 逆富士型	保守率	
器具品番	IRLDFL22FJ	良	0.81
部品品名		中	0.77
部品品番	-	否	0.67
器具光束	1880lm	器具効率	
光源	LDG20S・WW/9/10	上方向	4%
光源光束	1000lm × 2	下方向	90%
		全方向	94%

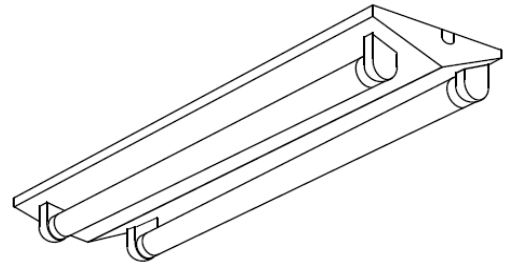

照明率表

		作業面照明率(×0.01)																						
反射率	天井	80								70				50				30		0				
	壁	70	50	30	10	70	50	30	10	70	50	30	10	50	30	10	30	10	30	10	0	0		
床	30	10	30	10	30	10	10	30	10	30	10	30	10	10	30	10	30	10	30	10	10	0		
室 指 数	0.4	40	38	28	27	20	20	16	39	37	27	26	20	20	16	26	25	20	20	16	20	19	15	14
	0.6	55	51	42	39	33	32	27	54	50	41	39	33	32	27	39	38	32	31	27	31	31	27	25
	0.8	65	59	50	47	41	39	34	63	57	49	47	41	39	34	47	45	40	38	33	39	38	33	31
	1	73	65	59	54	49	47	41	70	64	57	53	48	46	41	55	52	47	45	40	46	44	40	38
	1.25	80	71	67	61	58	54	48	77	70	65	60	57	53	48	62	59	55	52	47	53	51	47	45
	1.5	85	75	73	66	63	59	53	82	73	71	65	62	58	53	67	63	60	57	52	58	56	51	49
	2	92	80	81	73	72	66	61	89	79	79	71	71	65	60	75	69	68	64	59	65	63	59	56
	2.5	98	84	88	77	79	72	67	94	82	85	76	78	71	66	80	74	74	69	65	71	68	64	62
	3	101	86	92	80	84	75	71	97	85	89	79	82	74	70	84	77	78	73	69	74	71	68	65
	4	105	90	98	85	91	80	76	101	88	95	83	89	79	76	89	81	84	78	74	80	76	73	70
5	108	92	102	87	96	84	80	104	90	98	86	93	83	79	92	84	88	81	78	83	79	77	74	
7	112	94	107	91	102	88	85	107	92	103	89	99	87	84	96	87	93	85	83	87	83	81	78	
10	114	96	111	93	107	91	89	110	94	107	92	103	90	88	99	90	97	88	86	91	86	84	82	

配光曲線

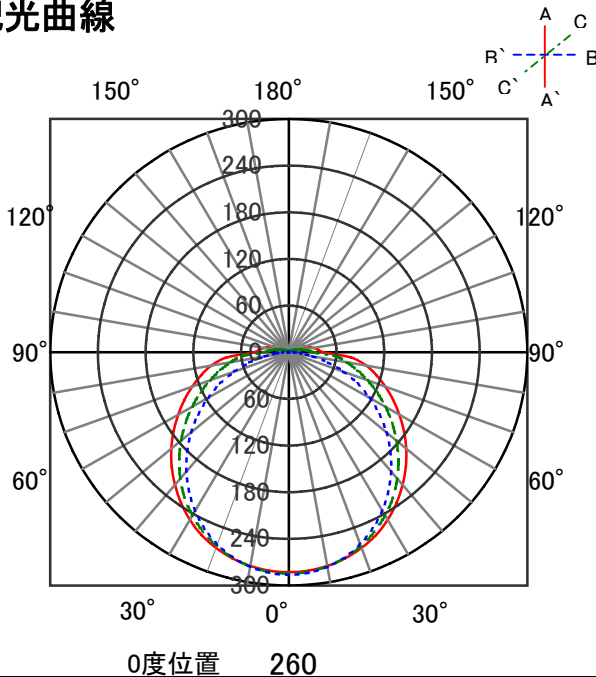

直射水平面照度

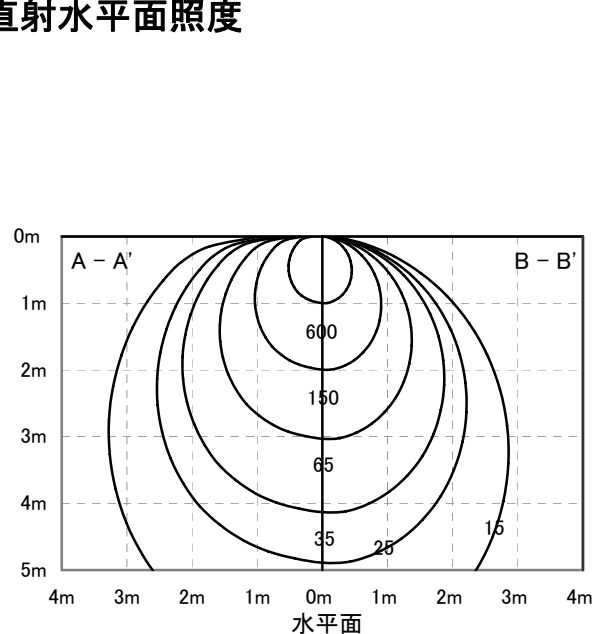

ECOHiLUX照明器具 配光データシート

意匠図

器具品名	直管形LEDランプ 専用器具 逆富士型	保守率	
器具品番	IRLDFL22FJ	良	0.81
部品品名		中	0.77
部品品番	-	否	0.67
器具光束	1880lm	器具効率	
光源	LDG20S・W/8/10	上方向	4%
光源光束	1000lm × 2	下方向	90%
		全方向	94%

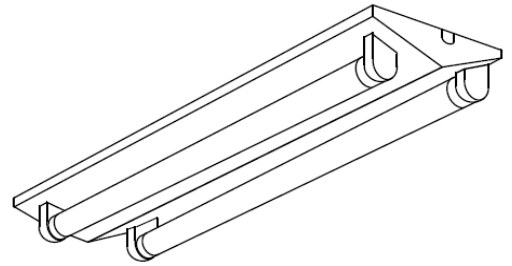

照明率表

		作業面照明率(×0.01)																						
反射率	天井	80								70				50				30		0				
	壁	70	50	30	10	70	50	30	10	70	50	30	10	50	30	10	30	10	30	10	10	0		
床	30	10	30	10	30	10	10	30	10	30	10	30	10	10	30	10	30	10	10	30	10	10	0	
室 指 数	0.4	40	38	28	27	20	20	16	39	37	27	26	20	20	16	26	25	20	20	16	20	19	15	14
	0.6	55	51	42	39	33	32	27	54	50	41	39	33	32	27	39	38	32	31	27	31	31	27	25
	0.8	65	59	50	47	41	39	34	63	57	49	47	41	39	34	47	45	40	38	33	39	38	33	31
	1	73	65	59	54	49	47	41	70	64	57	53	48	46	41	55	52	47	45	40	46	44	40	38
	1.25	80	71	67	61	58	54	48	77	70	65	60	57	53	48	62	59	55	52	47	53	51	47	45
	1.5	85	75	73	66	63	59	53	82	73	71	65	62	58	53	67	63	60	57	52	58	56	51	49
	2	92	80	81	73	72	66	61	89	79	79	71	71	65	60	75	69	68	64	59	65	63	59	56
	2.5	98	84	88	77	79	72	67	94	82	85	76	78	71	66	80	74	74	69	65	71	68	64	62
	3	101	86	92	80	84	75	71	97	85	89	79	82	74	70	84	77	78	73	69	74	71	68	65
	4	105	90	98	85	91	80	76	101	88	95	83	89	79	76	89	81	84	78	74	80	76	73	70
5	108	92	102	87	96	84	80	104	90	98	86	93	83	79	92	84	88	81	78	83	79	77	74	
7	112	94	107	91	102	88	85	107	92	103	89	99	87	84	96	87	93	85	83	87	83	81	78	
10	114	96	111	93	107	91	89	110	94	107	92	103	90	88	99	90	97	88	86	91	86	84	82	

配光曲線

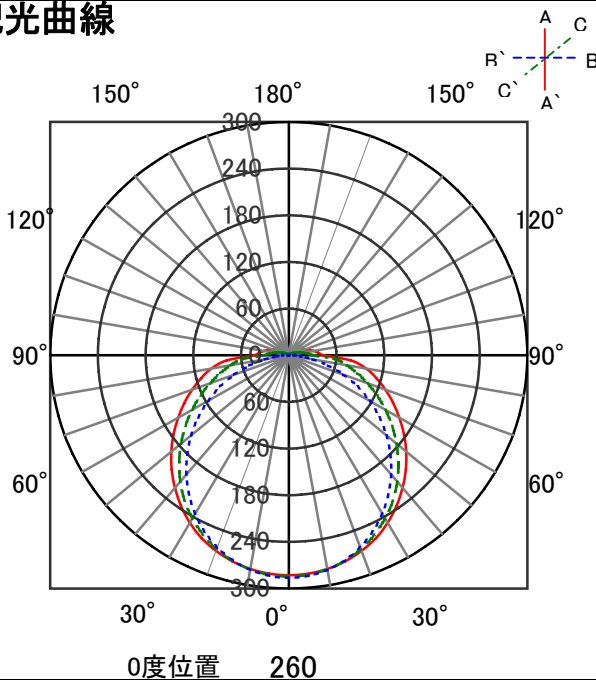

直射水平面照度

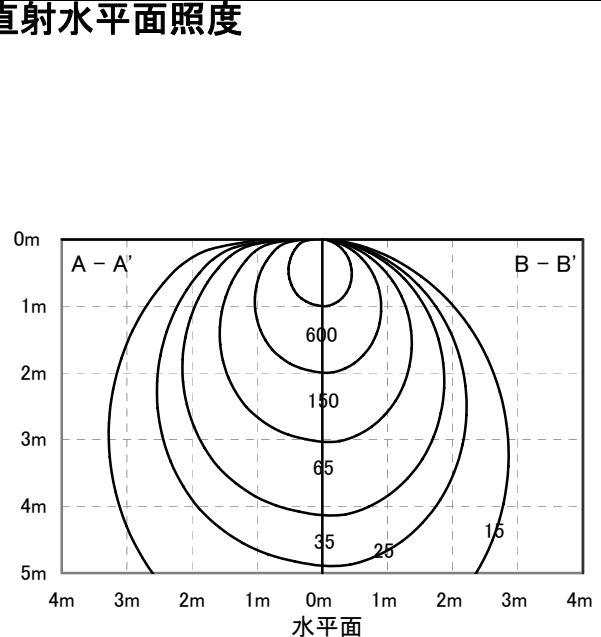

ECOHiLUX照明器具 配光データシート

意匠図

器具品名	直管形LEDランプ 専用器具 逆富士型	保守率	
器具品番	IRLDFL22FJ	良	0.81
部品品名		中	0.77
部品品番	-	否	0.67
		器具効率	
器具光束	1880lm	上方向	4%
光源	LDG20S・N/8/10	下方向	90%
光源光束	1000lm × 2	全方向	94%

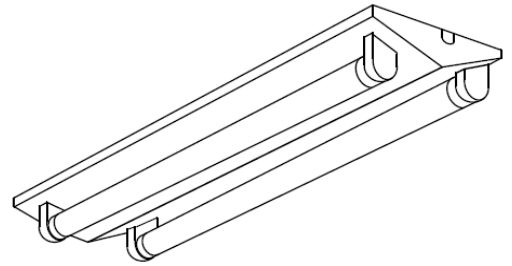

照明率表

		作業面照明率(×0.01)																						
反射率	天井	80				70				50				30				0						
	壁	70	50	30	10	70	50	30	10	50	30	10	10	30	10	10	0	30	10	10	0			
	床	30	10	30	10	30	10	10	30	10	30	10	10	30	10	30	10	10	30	10	10	0		
室 指 数	0.4	40	38	28	27	20	20	16	39	37	27	26	20	20	16	26	25	20	20	16	20	19	15	14
	0.6	55	51	42	39	33	32	27	54	50	41	39	33	32	27	39	38	32	31	27	31	31	27	25
	0.8	65	59	50	47	41	39	34	63	57	49	47	41	39	34	47	45	40	38	33	39	38	33	31
	1	73	65	59	54	49	47	41	70	64	57	53	48	46	41	55	52	47	45	40	46	44	40	38
	1.25	80	71	67	61	58	54	48	77	70	65	60	57	53	48	62	59	55	52	47	53	51	47	45
	1.5	85	75	73	66	63	59	53	82	73	71	65	62	58	53	67	63	60	57	52	58	56	51	49
	2	92	80	81	73	72	66	61	89	79	79	71	71	65	60	75	69	68	64	59	65	63	59	56
	2.5	98	84	88	77	79	72	67	94	82	85	76	78	71	66	80	74	74	69	65	71	68	64	62
	3	101	86	92	80	84	75	71	97	85	89	79	82	74	70	84	77	78	73	69	74	71	68	65
	4	105	90	98	85	91	80	76	101	88	95	83	89	79	76	89	81	84	78	74	80	76	73	70
5	108	92	102	87	96	84	80	104	90	98	86	93	83	79	92	84	88	81	78	83	79	77	74	
7	112	94	107	91	102	88	85	107	92	103	89	99	87	84	96	87	93	85	83	87	83	81	78	
10	114	96	111	93	107	91	89	110	94	107	92	103	90	88	99	90	97	88	86	91	86	84	82	

配光曲線

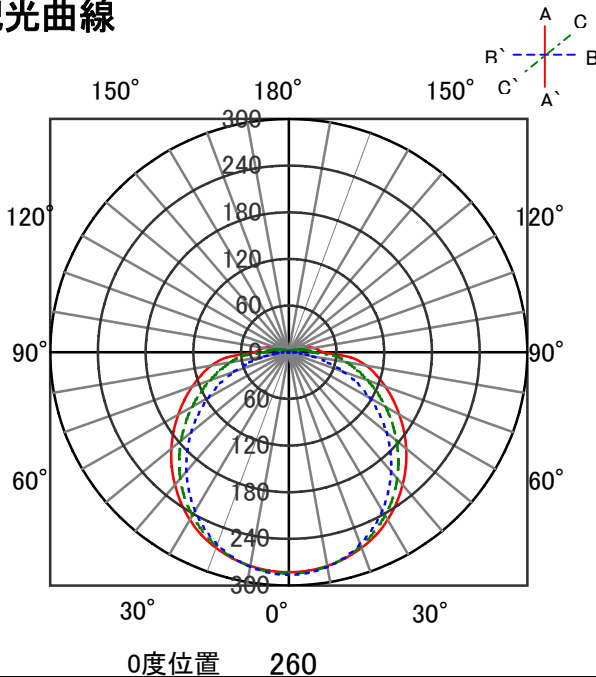

直射水平面照度

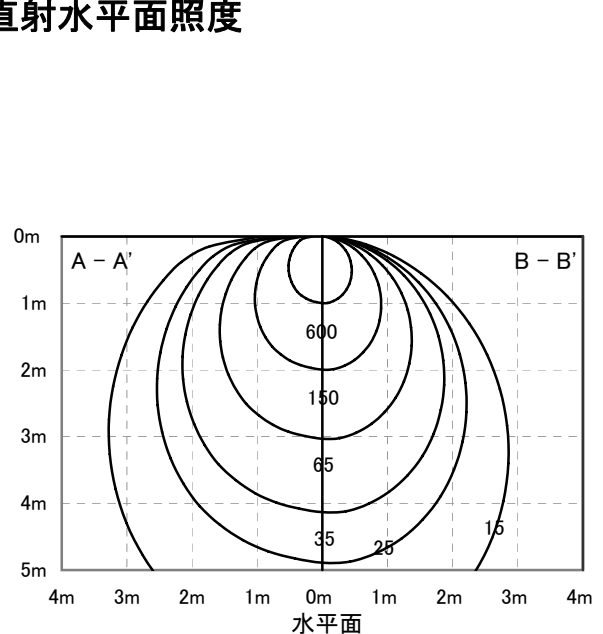

ECOHiLUX照明器具 配光データシート

意匠図

器具品名	直管形LEDランプ 専用器具 逆富士型	保守率	
器具品番	IRLDFL22FJ	良	0.81
部品品名		中	0.77
部品品番	-	否	0.67
器具光束	1880lm	器具効率	
光源	LDG20S・D/8/10	上方向	4%
光源光束	1000lm × 2	下方向	90%
		全方向	94%

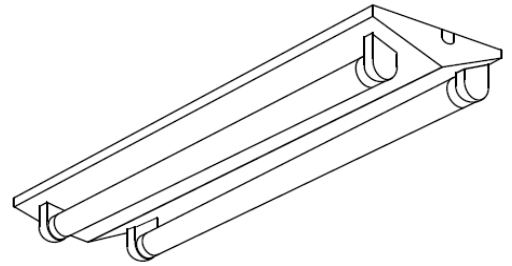

照明率表

		作業面照明率(×0.01)																						
反射率	天井	80								70				50				30		0				
	壁	70	50	30	10	70	50	30	10	70	50	30	10	50	30	10	30	10	30	10	10	0		
床	30	10	30	10	30	10	10	30	10	30	10	30	10	10	30	10	30	10	30	10	10	0		
室 指 数	0.4	40	38	28	27	20	20	16	39	37	27	26	20	20	16	26	25	20	20	16	20	19	15	14
	0.6	55	51	42	39	33	32	27	54	50	41	39	33	32	27	39	38	32	31	27	31	31	27	25
	0.8	65	59	50	47	41	39	34	63	57	49	47	41	39	34	47	45	40	38	33	39	38	33	31
	1	73	65	59	54	49	47	41	70	64	57	53	48	46	41	55	52	47	45	40	46	44	40	38
	1.25	80	71	67	61	58	54	48	77	70	65	60	57	53	48	62	59	55	52	47	53	51	47	45
	1.5	85	75	73	66	63	59	53	82	73	71	65	62	58	53	67	63	60	57	52	58	56	51	49
	2	92	80	81	73	72	66	61	89	79	79	71	71	65	60	75	69	68	64	59	65	63	59	56
	2.5	98	84	88	77	79	72	67	94	82	85	76	78	71	66	80	74	74	69	65	71	68	64	62
	3	101	86	92	80	84	75	71	97	85	89	79	82	74	70	84	77	78	73	69	74	71	68	65
	4	105	90	98	85	91	80	76	101	88	95	83	89	79	76	89	81	84	78	74	80	76	73	70
5	108	92	102	87	96	84	80	104	90	98	86	93	83	79	92	84	88	81	78	83	79	77	74	
7	112	94	107	91	102	88	85	107	92	103	89	99	87	84	96	87	93	85	83	87	83	81	78	
10	114	96	111	93	107	91	89	110	94	107	92	103	90	88	99	90	97	88	86	91	86	84	82	

配光曲線

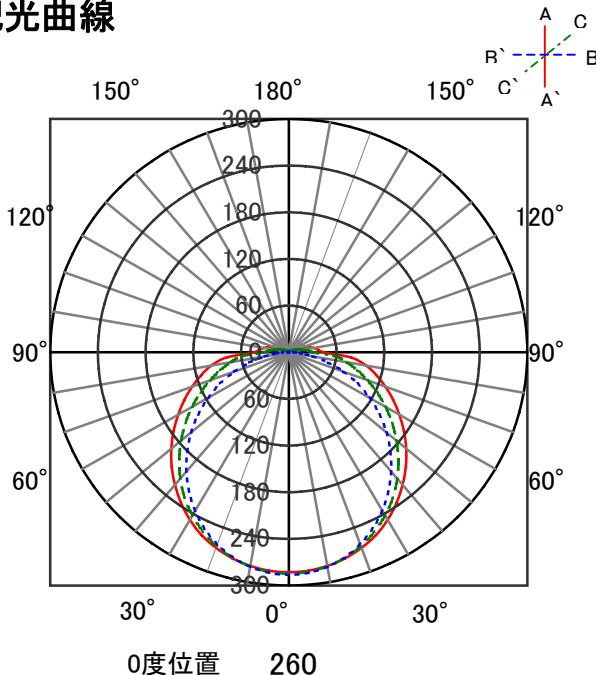

直射水平面照度

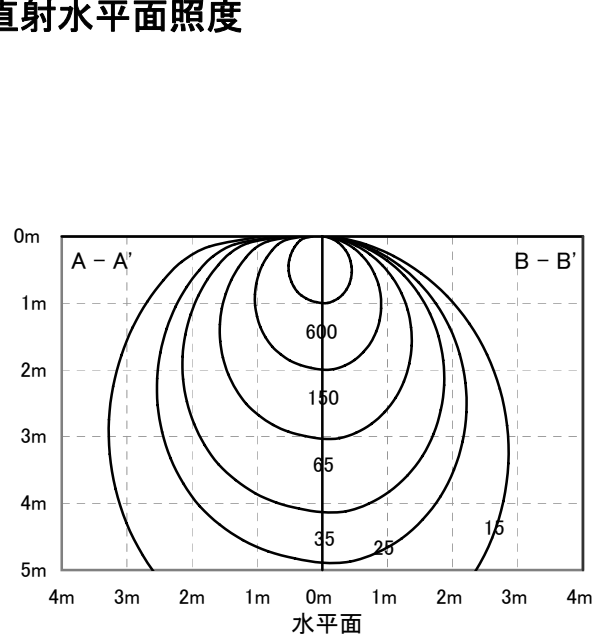

ECOHiLUX照明器具 配光データシート

意匠図

器具品名	直管形LEDランプ 専用器具 逆富士型	保守率	
器具品番	IRLDL22FJ	良	0.81
部品品名		中	0.77
部品品番	-	否	0.67
器具光束	1880lm	器具効率	
光源	LDG20S・WW/12/10/D	上方向	4%
光源光束	1000lm × 2	下方向	90%
		全方向	94%

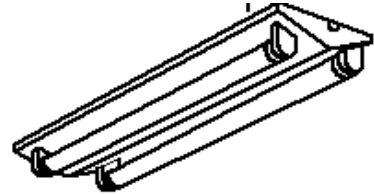

照明率表

		作業面照明率(×0.01)																						
反射率	天井	80				70				50				30				0						
	壁	70	50	30	10	70	50	30	10	50	30	10	10	30	10	10	10	30	10	10	0			
	床	30	10	30	10	30	10	10	30	10	30	10	10	30	10	30	10	10	30	10	10	0		
室 指 数	0.4	40	38	28	27	20	20	16	39	37	27	26	20	20	16	26	25	20	20	16	20	19	15	14
	0.6	55	51	42	39	33	32	27	54	50	41	39	33	32	27	39	38	32	31	27	31	31	27	25
	0.8	65	59	50	47	41	39	34	63	57	49	47	41	39	34	47	45	40	38	33	39	38	33	31
	1	73	65	59	54	49	47	41	70	64	57	53	48	46	41	55	52	47	45	40	46	44	40	38
	1.25	80	71	67	61	58	54	48	77	70	65	60	57	53	48	62	59	55	52	47	53	51	47	45
	1.5	85	75	73	66	63	59	53	82	73	71	65	62	58	53	67	63	60	57	52	58	56	51	49
	2	92	80	81	73	72	66	61	89	79	79	71	71	65	60	75	69	68	64	59	65	63	59	56
	2.5	98	84	88	77	79	72	67	94	82	85	76	78	71	66	80	74	74	69	65	71	68	64	62
	3	101	86	92	80	84	75	71	97	85	89	79	82	74	70	84	77	78	73	69	74	71	68	65
	4	105	90	98	85	91	80	76	101	88	95	83	89	79	76	89	81	84	78	74	80	76	73	70
5	108	92	102	87	96	84	80	104	90	98	86	93	83	79	92	84	88	81	78	83	79	77	74	
7	112	94	107	91	102	88	85	107	92	103	89	99	87	84	96	87	93	85	83	87	83	81	78	
10	114	96	111	93	107	91	89	110	94	107	92	103	90	88	99	90	97	88	86	91	86	84	82	

配光曲線

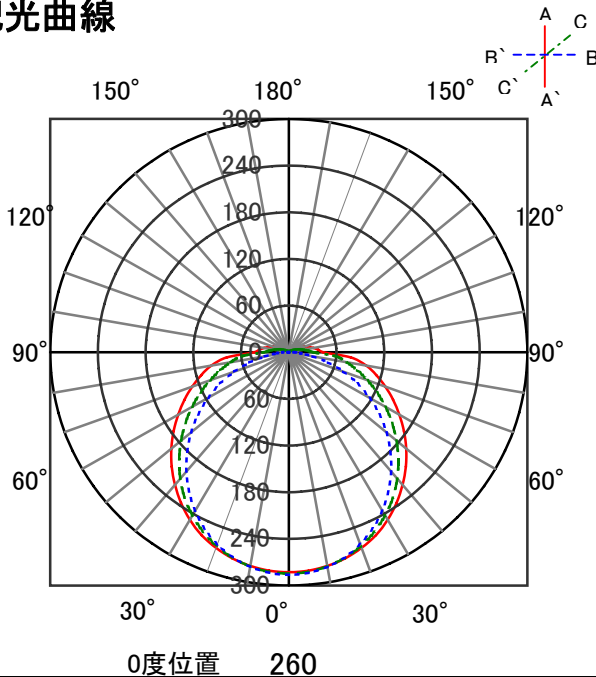

直射水平面照度

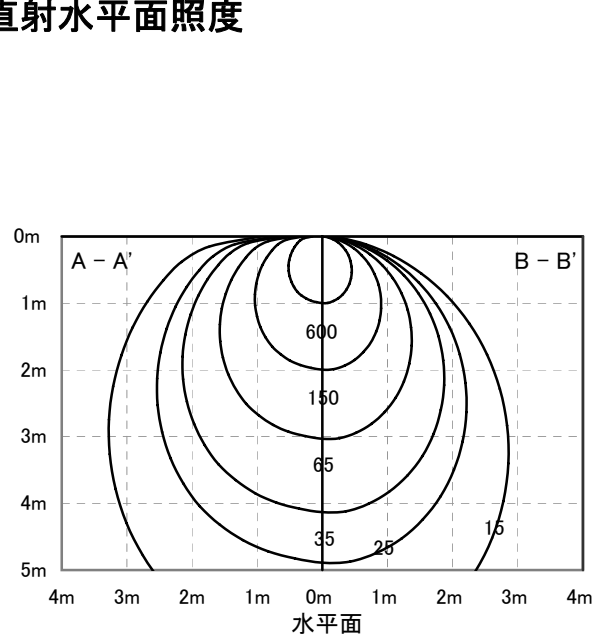

ECOHiLUX照明器具 配光データシート

意匠図

器具品名	直管形LEDランプ 専用器具 逆富士型	保守率	
器具品番	IRLDL22FJ	良	0.81
部品品名		中	0.77
部品品番	-	否	0.67
		器具効率	
器具光束	1880lm	上方向	4%
光源	LDG20S・W/12/10/D	下方向	90%
光源光束	1000lm × 2	全方向	94%

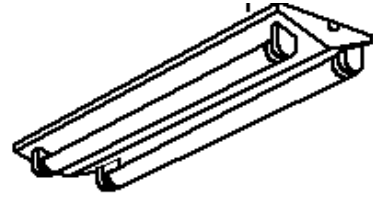

照明率表

		作業面照明率(×0.01)																						
反射率	天井	80								70				50				30		0				
	壁	70	50	30	10	70	50	30	10	70	50	30	10	50	30	10	30	10	30	10	0	0		
床		30	10	30	10	30	10	10	30	10	30	10	10	30	10	30	10	10	30	10	10	0		
室 指 数	0.4	40	38	28	27	20	20	16	39	37	27	26	20	16	26	25	20	20	16	20	19	15	14	
	0.6	55	51	42	39	33	32	27	54	50	41	39	33	32	27	39	38	32	31	27	31	31	27	25
	0.8	65	59	50	47	41	39	34	63	57	49	47	41	39	34	47	45	40	38	33	39	38	33	31
	1	73	65	59	54	49	47	41	70	64	57	53	48	46	41	55	52	47	45	40	46	44	40	38
	1.25	80	71	67	61	58	54	48	77	70	65	60	57	53	48	62	59	55	52	47	53	51	47	45
	1.5	85	75	73	66	63	59	53	82	73	71	65	62	58	53	67	63	60	57	52	58	56	51	49
	2	92	80	81	73	72	66	61	89	79	79	71	71	65	60	75	69	68	64	59	65	63	59	56
	2.5	98	84	88	77	79	72	67	94	82	85	76	78	71	66	80	74	74	69	65	71	68	64	62
	3	101	86	92	80	84	75	71	97	85	89	79	82	74	70	84	77	78	73	69	74	71	68	65
	4	105	90	98	85	91	80	76	101	88	95	83	89	79	76	89	81	84	78	74	80	76	73	70
5	108	92	102	87	96	84	80	104	90	98	86	93	83	79	92	84	88	81	78	83	79	77	74	
7	112	94	107	91	102	88	85	107	92	103	89	99	87	84	96	87	93	85	83	87	83	81	78	
10	114	96	111	93	107	91	89	110	94	107	92	103	90	88	99	90	97	88	86	91	86	84	82	

配光曲線

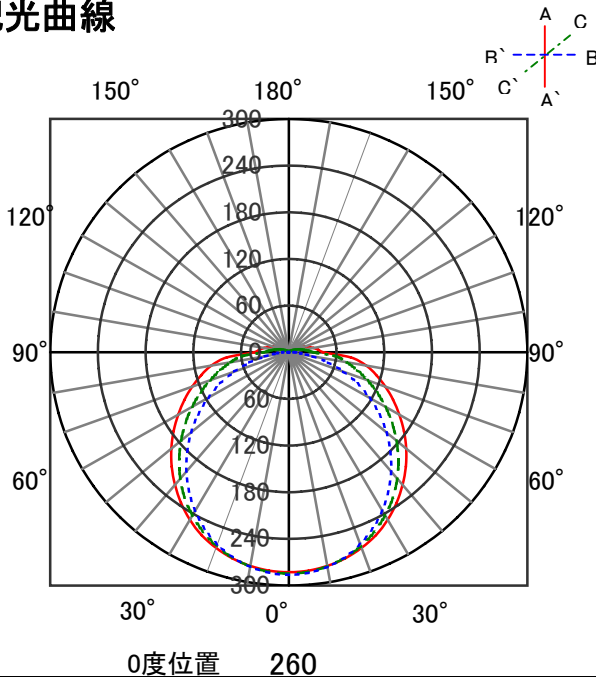

直射水平面照度

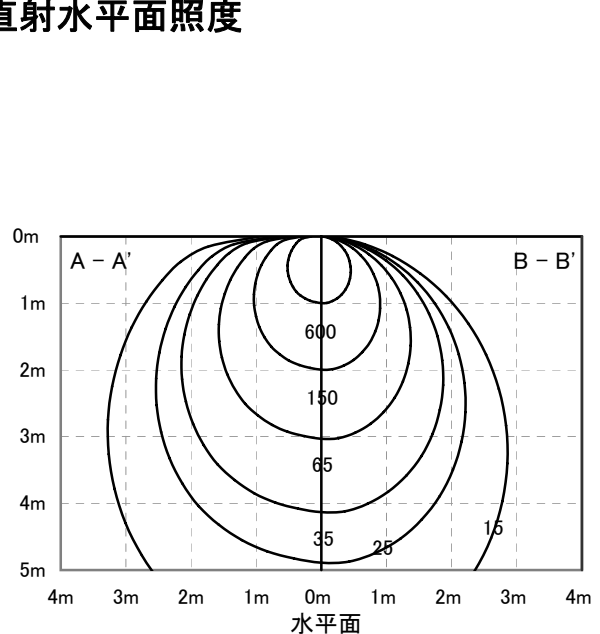

ECOHiLUX照明器具 配光データシート

意匠図

器具品名	直管形LEDランプ 専用器具 逆富士型	保守率	
器具品番	IRLDL22FJ	良	0.81
部品品名		中	0.77
部品品番	-	否	0.67
		器具効率	
器具光束	1880lm	上方向	4%
光源	LDG20S・N/12/10/D	下方向	90%
光源光束	1000lm × 2	全方向	94%

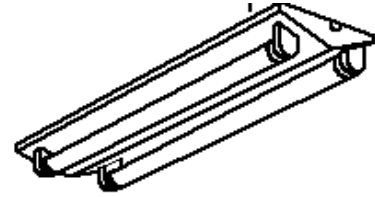

照明率表

反射率	天井	80								70				50				30		0					
		壁		70		50		30		10		70		50		30		10		30		10		0	
	床	30	10	30	10	30	10	10	30	10	30	10	30	10	10	30	10	30	10	10	30	10	10	0	0
室 指 数	0.4	40	38	28	27	20	20	16	39	37	27	26	20	20	16	26	25	20	20	16	20	19	15	14	
	0.6	55	51	42	39	33	32	27	54	50	41	39	33	32	27	39	38	32	31	27	31	31	27	25	
	0.8	65	59	50	47	41	39	34	63	57	49	47	41	39	34	47	45	40	38	33	39	38	33	31	
	1	73	65	59	54	49	47	41	70	64	57	53	48	46	41	55	52	47	45	40	46	44	40	38	
	1.25	80	71	67	61	58	54	48	77	70	65	60	57	53	48	62	59	55	52	47	53	51	47	45	
	1.5	85	75	73	66	63	59	53	82	73	71	65	62	58	53	67	63	60	57	52	58	56	51	49	
	2	92	80	81	73	72	66	61	89	79	79	71	71	65	60	75	69	68	64	59	65	63	59	56	
	2.5	98	84	88	77	79	72	67	94	82	85	76	78	71	66	80	74	74	69	65	71	68	64	62	
	3	101	86	92	80	84	75	71	97	85	89	79	82	74	70	84	77	78	73	69	74	71	68	65	
	4	105	90	98	85	91	80	76	101	88	95	83	89	79	76	89	81	84	78	74	80	76	73	70	
5	108	92	102	87	96	84	80	104	90	98	86	93	83	79	92	84	88	81	78	83	79	77	74		
7	112	94	107	91	102	88	85	107	92	103	89	99	87	84	96	87	93	85	83	87	83	81	78		
10	114	96	111	93	107	91	89	110	94	107	92	103	90	88	99	90	97	88	86	91	86	84	82		

配光曲線

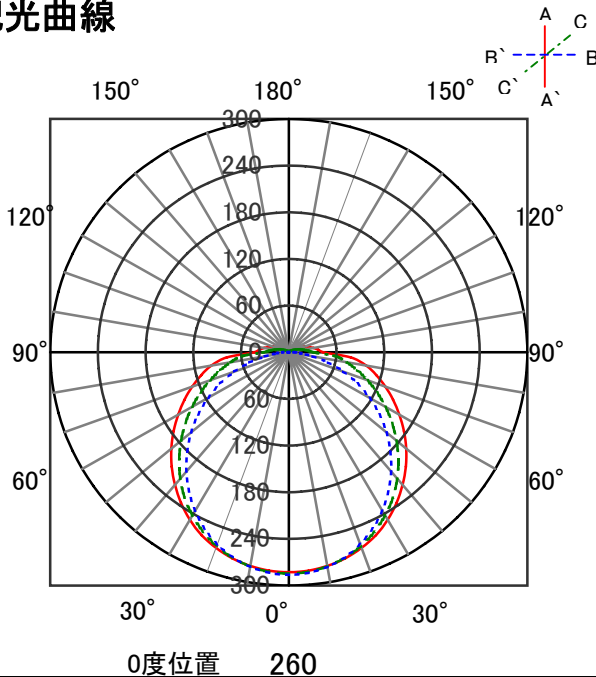

直射水平面照度

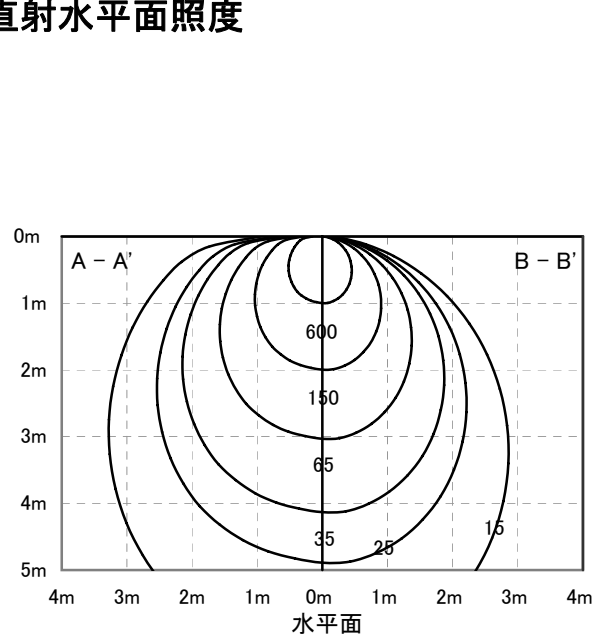

ECOHiLUX照明器具 配光データシート

意匠図

器具品名	直管形LEDランプ 専用器具 逆富士型	保守率	
器具品番	IRLDL22FJ	良	0.81
部品品名		中	0.77
部品品番	-	否	0.67
		器具効率	
器具光束	1880lm	上方向	4%
光源	LDGR20S・WW/12/10	下方向	90%
光源光束	1000lm × 2	全方向	94%

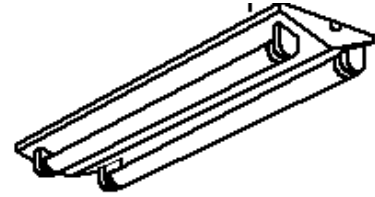

照明率表

		作業面照明率(×0.01)																						
反射率	天井	80								70				50				30		0				
	壁	70	50	30	10	70	50	30	10	70	50	30	10	50	30	10	30	10	30	10	10	0		
床	30	10	30	10	30	10	10	30	10	30	10	30	10	10	30	10	30	10	10	30	10	10	0	
室 指 数	0.4	40	38	28	27	20	20	16	39	37	27	26	20	20	16	26	25	20	20	16	20	19	15	14
	0.6	55	51	42	39	33	32	27	54	50	41	39	33	32	27	39	38	32	31	27	31	31	27	25
	0.8	65	59	50	47	41	39	34	63	57	49	47	41	39	34	47	45	40	38	33	39	38	33	31
	1	73	65	59	54	49	47	41	70	64	57	53	48	46	41	55	52	47	45	40	46	44	40	38
	1.25	80	71	67	61	58	54	48	77	70	65	60	57	53	48	62	59	55	52	47	53	51	47	45
	1.5	85	75	73	66	63	59	53	82	73	71	65	62	58	53	67	63	60	57	52	58	56	51	49
	2	92	80	81	73	72	66	61	89	79	79	71	71	65	60	75	69	68	64	59	65	63	59	56
	2.5	98	84	88	77	79	72	67	94	82	85	76	78	71	66	80	74	74	69	65	71	68	64	62
	3	101	86	92	80	84	75	71	97	85	89	79	82	74	70	84	77	78	73	69	74	71	68	65
	4	105	90	98	85	91	80	76	101	88	95	83	89	79	76	89	81	84	78	74	80	76	73	70
5	108	92	102	87	96	84	80	104	90	98	86	93	83	79	92	84	88	81	78	83	79	77	74	
7	112	94	107	91	102	88	85	107	92	103	89	99	87	84	96	87	93	85	83	87	83	81	78	
10	114	96	111	93	107	91	89	110	94	107	92	103	90	88	99	90	97	88	86	91	86	84	82	

配光曲線

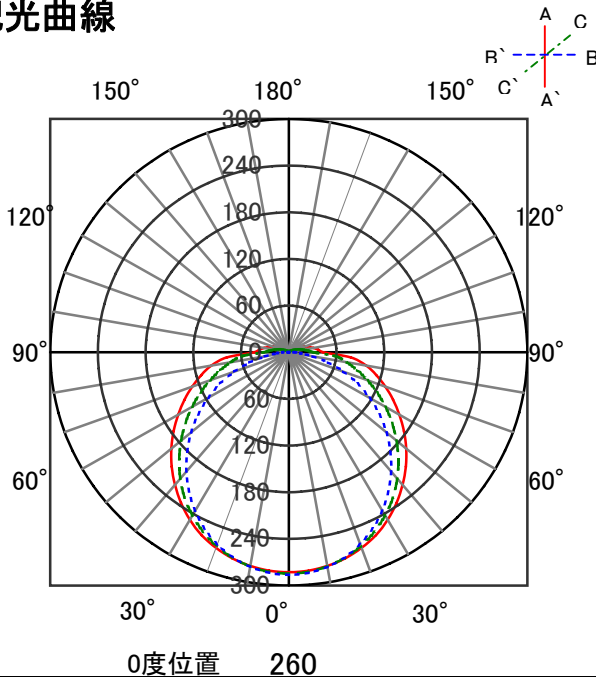

直射水平面照度

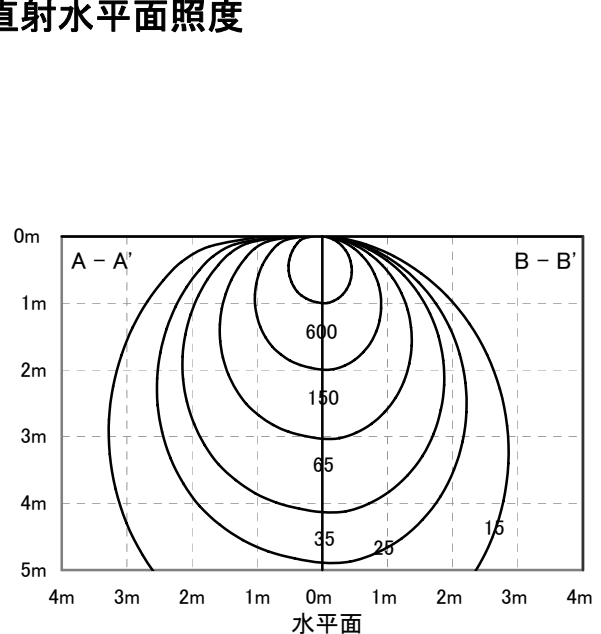

ECOHiLUX照明器具 配光データシート

意匠図

器具品名	直管形LEDランプ 専用器具 逆富士型	保守率	
器具品番	IRLDL22FJ	良	0.81
部品品名		中	0.77
部品品番	-	否	0.67
		器具効率	
器具光束	1880lm	上方向	4%
光源	LDGR20S・W/12/10	下方向	90%
光源光束	1000lm × 2	全方向	94%

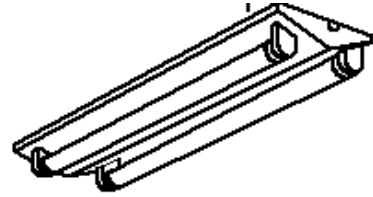

照明率表

		作業面照明率(×0.01)																								
反射率	天井	80								70				50				30		0						
	壁	70	10	30	10	30	10	10	10	70	10	30	10	30	10	10	10	50	10	30	10	10	10	30	10	10
室 指 数	0.4	40	38	28	27	20	20	16	39	37	27	26	20	20	16	26	25	20	20	16	20	19	15	14		
	0.6	55	51	42	39	33	32	27	54	50	41	39	33	32	27	39	38	32	31	27	31	31	27	25		
	0.8	65	59	50	47	41	39	34	63	57	49	47	41	39	34	47	45	40	38	33	39	38	33	31		
	1	73	65	59	54	49	47	41	70	64	57	53	48	46	41	55	52	47	45	40	46	44	40	38		
	1.25	80	71	67	61	58	54	48	77	70	65	60	57	53	48	62	59	55	52	47	53	51	47	45		
	1.5	85	75	73	66	63	59	53	82	73	71	65	62	58	53	67	63	60	57	52	58	56	51	49		
	2	92	80	81	73	72	66	61	89	79	79	71	71	65	60	75	69	68	64	59	65	63	59	56		
	2.5	98	84	88	77	79	72	67	94	82	85	76	78	71	66	80	74	74	69	65	71	68	64	62		
	3	101	86	92	80	84	75	71	97	85	89	79	82	74	70	84	77	78	73	69	74	71	68	65		
	4	105	90	98	85	91	80	76	101	88	95	83	89	79	76	89	81	84	78	74	80	76	73	70		
5	108	92	102	87	96	84	80	104	90	98	86	93	83	79	92	84	88	81	78	83	79	77	74			
7	112	94	107	91	102	88	85	107	92	103	89	99	87	84	96	87	93	85	83	87	83	81	78			
10	114	96	111	93	107	91	89	110	94	107	92	103	90	88	99	90	97	88	86	91	86	84	82			

配光曲線

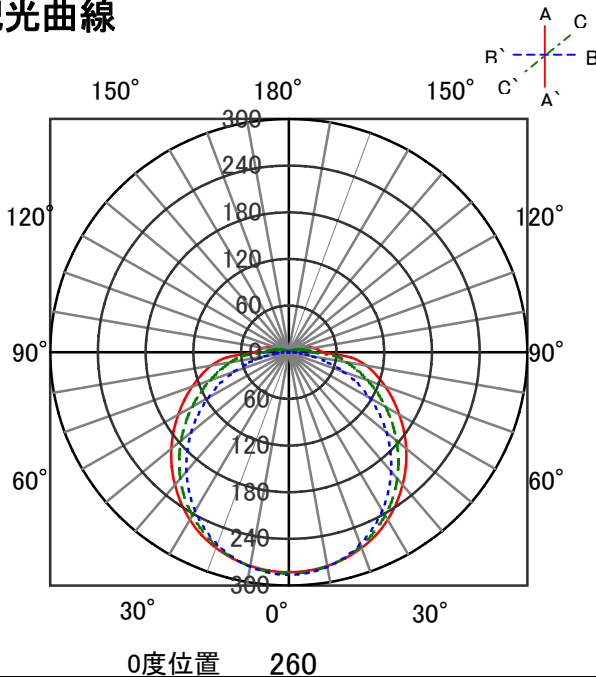

直射水平面照度

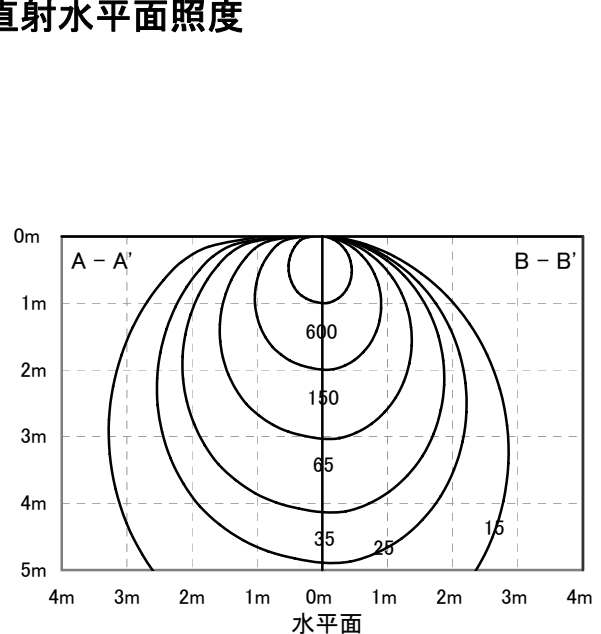

ECOHiLUX照明器具 配光データシート

意匠図

器具品名	直管形LEDランプ 専用器具 逆富士型	保守率	
器具品番	IRLDFL22FJ	良	0.81
部品品名		中	0.77
部品品番	-	否	0.67
器具光束	1880lm	器具効率	
光源	LDGR20S・N/12/10	上方向	4%
光源光束	1000lm × 2	下方向	90%
		全方向	94%

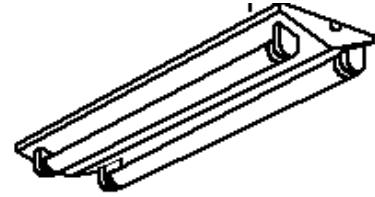

照明率表

		作業面照明率(×0.01)																								
反射率	天井	80								70				50				30		0						
	壁	70	10	30	10	30	10	10	10	70	10	30	10	30	10	10	10	50	10	30	10	10	10	30	10	10
室 指 数	0.4	40	38	28	27	20	20	16	39	37	27	26	20	20	16	26	25	20	20	16	20	19	15	14		
	0.6	55	51	42	39	33	32	27	54	50	41	39	33	32	27	39	38	32	31	27	31	31	27	25		
	0.8	65	59	50	47	41	39	34	63	57	49	47	41	39	34	47	45	40	38	33	39	38	33	31		
	1	73	65	59	54	49	47	41	70	64	57	53	48	46	41	55	52	47	45	40	46	44	40	38		
	1.25	80	71	67	61	58	54	48	77	70	65	60	57	53	48	62	59	55	52	47	53	51	47	45		
	1.5	85	75	73	66	63	59	53	82	73	71	65	62	58	53	67	63	60	57	52	58	56	51	49		
	2	92	80	81	73	72	66	61	89	79	79	71	71	65	60	75	69	68	64	59	65	63	59	56		
	2.5	98	84	88	77	79	72	67	94	82	85	76	78	71	66	80	74	74	69	65	71	68	64	62		
	3	101	86	92	80	84	75	71	97	85	89	79	82	74	70	84	77	78	73	69	74	71	68	65		
	4	105	90	98	85	91	80	76	101	88	95	83	89	79	76	89	81	84	78	74	80	76	73	70		
5	108	92	102	87	96	84	80	104	90	98	86	93	83	79	92	84	88	81	78	83	79	77	74			
7	112	94	107	91	102	88	85	107	92	103	89	99	87	84	96	87	93	85	83	87	83	81	78			
10	114	96	111	93	107	91	89	110	94	107	92	103	90	88	99	90	97	88	86	91	86	84	82			

配光曲線

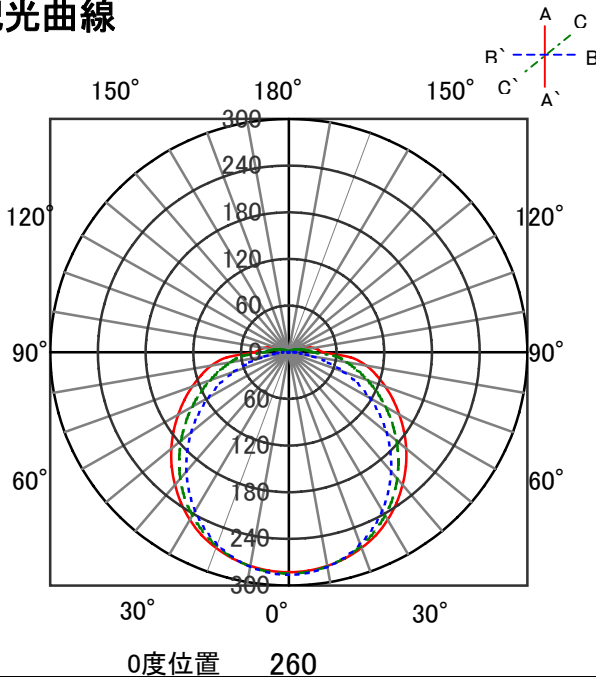

直射水平面照度

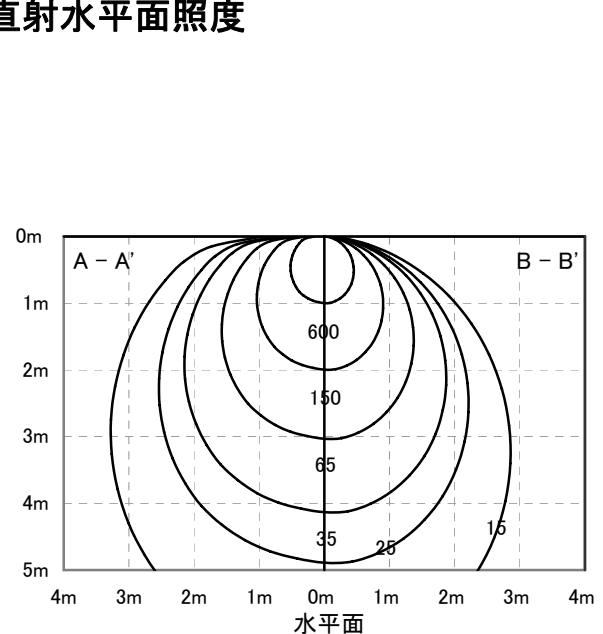

ECOHiLUX照明器具 配光データシート

意匠図

器具品名	直管形LEDランプ 専用器具 逆富士型	保守率	
器具品番	IRLDFL22FJ	良	0.81
部品品名		中	0.77
部品品番	-	否	0.67
		器具効率	
器具光束	1880lm	上方向	4%
光源	LDFL1000WS-H40	下方向	90%
光源光束	1000lm × 2	全方向	94%

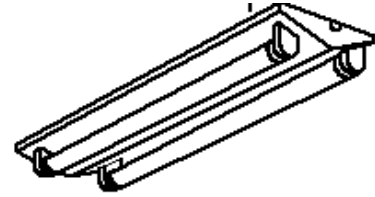

照明率表

		作業面照明率(×0.01)																						
反射率	天井	80				70				50				30				0						
	壁	70	50	30	10	70	50	30	10	50	30	10	10	30	10	10	10	30	10	10	0			
	床	30	10	30	10	30	10	10	30	10	30	10	10	30	10	30	10	10	30	10	10	0		
室 指 数	0.4	40	38	28	27	20	20	16	39	37	27	26	20	16	26	25	20	20	16	20	19	15	14	
	0.6	55	51	42	39	33	32	27	54	50	41	39	33	32	27	39	38	32	31	27	31	31	27	25
	0.8	65	59	50	47	41	39	34	63	57	49	47	41	39	34	47	45	40	38	33	39	38	33	31
	1	73	65	59	54	49	47	41	70	64	57	53	48	46	41	55	52	47	45	40	46	44	40	38
	1.25	80	71	67	61	58	54	48	77	70	65	60	57	53	48	62	59	55	52	47	53	51	47	45
	1.5	85	75	73	66	63	59	53	82	73	71	65	62	58	53	67	63	60	57	52	58	56	51	49
	2	92	80	81	73	72	66	61	89	79	79	71	71	65	60	75	69	68	64	59	65	63	59	56
	2.5	98	84	88	77	79	72	67	94	82	85	76	78	71	66	80	74	74	69	65	71	68	64	62
	3	101	86	92	80	84	75	71	97	85	89	79	82	74	70	84	77	78	73	69	74	71	68	65
	4	105	90	98	85	91	80	76	101	88	95	83	89	79	76	89	81	84	78	74	80	76	73	70
5	108	92	102	87	96	84	80	104	90	98	86	93	83	79	92	84	88	81	78	83	79	77	74	
7	112	94	107	91	102	88	85	107	92	103	89	99	87	84	96	87	93	85	83	87	83	81	78	
10	114	96	111	93	107	91	89	110	94	107	92	103	90	88	99	90	97	88	86	91	86	84	82	

配光曲線

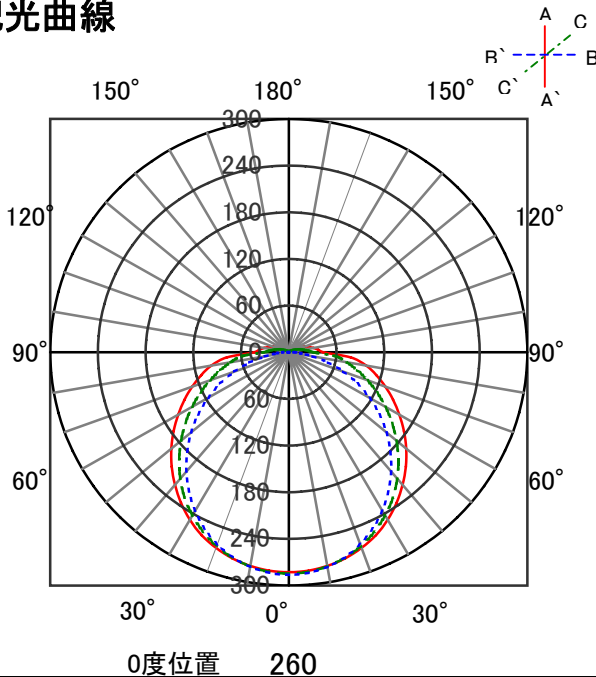

直射水平面照度

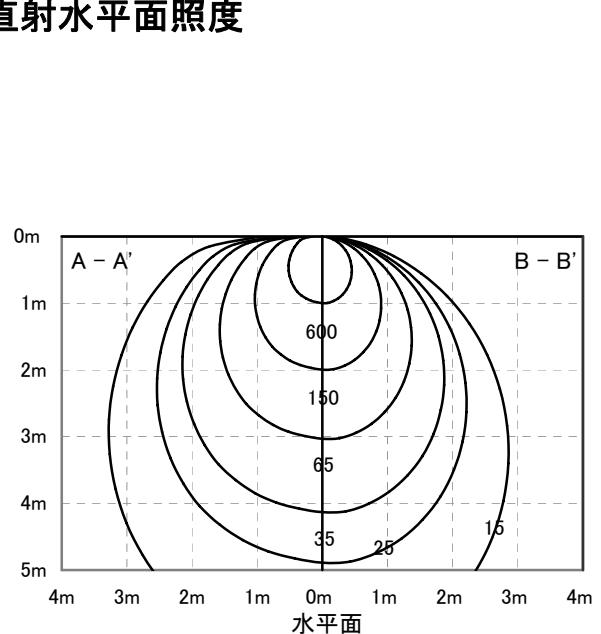

ECOHiLUX照明器具 配光データシート

意匠図

器具品名	直管形LEDランプ 専用器具 逆富士型	保守率	
器具品番	IRLDL22FJ	良	0.81
部品品名		中	0.77
部品品番	-	否	0.67
		器具効率	
器具光束	1880lm	上方向	4%
光源	LDLFL1000NS	下方向	90%
光源光束	1000lm × 2	全方向	94%

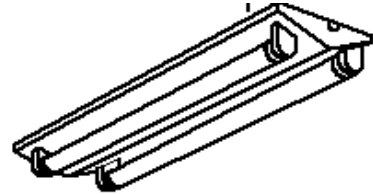

照明率表

		作業面照明率(×0.01)																						
反射率	天井 壁 床	80				70				50				30				0						
		70	50	30	10	70	50	30	10	50	30	10	10	30	10	10	30	10	10	0				
室 指 数	0.4	40	38	28	27	20	20	16	39	37	27	26	20	20	16	26	25	20	20	16	20	19	15	14
	0.6	55	51	42	39	33	32	27	54	50	41	39	33	32	27	39	38	32	31	27	31	31	27	25
	0.8	65	59	50	47	41	39	34	63	57	49	47	41	39	34	47	45	40	38	33	39	38	33	31
	1	73	65	59	54	49	47	41	70	64	57	53	48	46	41	55	52	47	45	40	46	44	40	38
	1.25	80	71	67	61	58	54	48	77	70	65	60	57	53	48	62	59	55	52	47	53	51	47	45
	1.5	85	75	73	66	63	59	53	82	73	71	65	62	58	53	67	63	60	57	52	58	56	51	49
	2	92	80	81	73	72	66	61	89	79	79	71	71	65	60	75	69	68	64	59	65	63	59	56
	2.5	98	84	88	77	79	72	67	94	82	85	76	78	71	66	80	74	74	69	65	71	68	64	62
	3	101	86	92	80	84	75	71	97	85	89	79	82	74	70	84	77	78	73	69	74	71	68	65
	4	105	90	98	85	91	80	76	101	88	95	83	89	79	76	89	81	84	78	74	80	76	73	70
5	108	92	102	87	96	84	80	104	90	98	86	93	83	79	92	84	88	81	78	83	79	77	74	
7	112	94	107	91	102	88	85	107	92	103	89	99	87	84	96	87	93	85	83	87	83	81	78	
10	114	96	111	93	107	91	89	110	94	107	92	103	90	88	99	90	97	88	86	91	86	84	82	

配光曲線

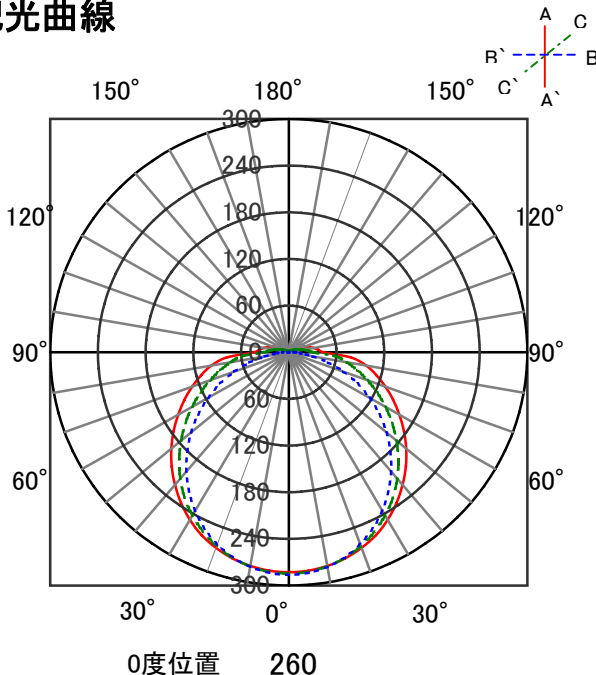

直射水平面照度

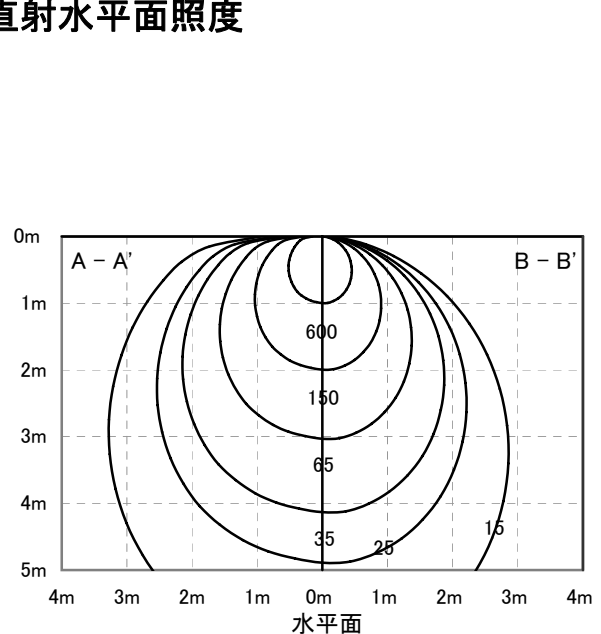

ECOHiLUX照明器具 配光データシート

意匠図

器具品名	直管形LEDランプ 専用器具 逆富士型	保守率	
器具品番	IRLDFL22FJ	良	0.81
部品品名		中	0.77
部品品番	-	否	0.67
		器具効率	
器具光束	1880lm	上方向	4%
光源	LDFL1000WWF-H35	下方向	90%
光源光束	1000lm × 2	全方向	94%

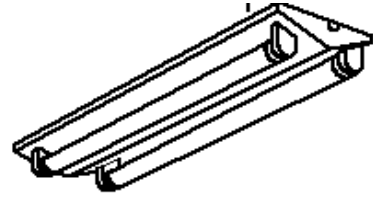

照明率表

		作業面照明率(×0.01)																						
反射率	天井	80								70				50				30		0				
	壁	70	50	30	10	70	50	30	10	70	50	30	10	50	30	10	30	10	30	10	10	0		
床	30	10	30	10	30	10	10	30	10	30	10	30	10	10	30	10	30	10	10	30	10	10	0	
室 指 数	0.4	40	38	28	27	20	20	16	39	37	27	26	20	20	16	26	25	20	20	16	20	19	15	14
	0.6	55	51	42	39	33	32	27	54	50	41	39	33	32	27	39	38	32	31	27	31	31	27	25
	0.8	65	59	50	47	41	39	34	63	57	49	47	41	39	34	47	45	40	38	33	39	38	33	31
	1	73	65	59	54	49	47	41	70	64	57	53	48	46	41	55	52	47	45	40	46	44	40	38
	1.25	80	71	67	61	58	54	48	77	70	65	60	57	53	48	62	59	55	52	47	53	51	47	45
	1.5	85	75	73	66	63	59	53	82	73	71	65	62	58	53	67	63	60	57	52	58	56	51	49
	2	92	80	81	73	72	66	61	89	79	79	71	71	65	60	75	69	68	64	59	65	63	59	56
	2.5	98	84	88	77	79	72	67	94	82	85	76	78	71	66	80	74	74	69	65	71	68	64	62
	3	101	86	92	80	84	75	71	97	85	89	79	82	74	70	84	77	78	73	69	74	71	68	65
	4	105	90	98	85	91	80	76	101	88	95	83	89	79	76	89	81	84	78	74	80	76	73	70
5	108	92	102	87	96	84	80	104	90	98	86	93	83	79	92	84	88	81	78	83	79	77	74	
7	112	94	107	91	102	88	85	107	92	103	89	99	87	84	96	87	93	85	83	87	83	81	78	
10	114	96	111	93	107	91	89	110	94	107	92	103	90	88	99	90	97	88	86	91	86	84	82	

配光曲線

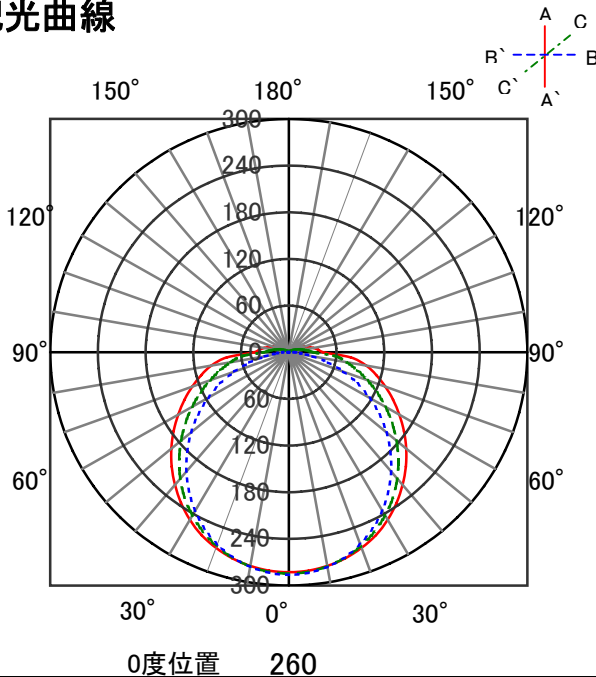

直射水平面照度

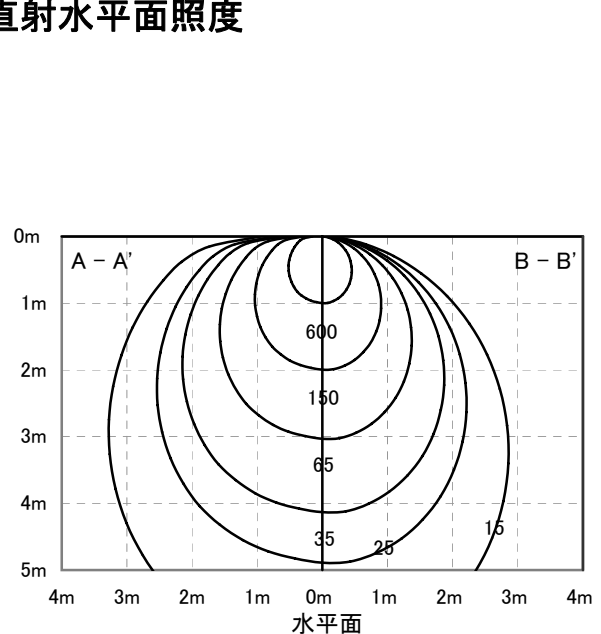

ECOHiLUX照明器具 配光データシート

意匠図

器具品名	直管形LEDランプ 専用器具 逆富士型	保守率	
器具品番	IRLDL22FJ	良	0.81
部品品名		中	0.77
部品品番	-	否	0.67
		器具効率	
器具光束	1880lm	上方向	4%
光源	LDFL1000WF-H40	下方向	90%
光源光束	1000lm × 2	全方向	94%

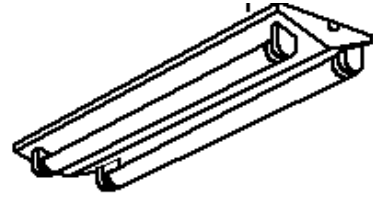

照明率表

		作業面照明率(×0.01)																						
反射率	天井	80				70				50				30				0						
	壁	70	50	30	10	70	50	30	10	50	30	10	10	30	10	10	0	30	10	10	0			
	床	30	10	30	10	30	10	10	30	10	30	10	10	30	10	30	10	10	30	10	10	0		
室 指 数	0.4	40	38	28	27	20	20	16	39	37	27	26	20	20	16	26	25	20	20	16	20	19	15	14
	0.6	55	51	42	39	33	32	27	54	50	41	39	33	32	27	39	38	32	31	27	31	31	27	25
	0.8	65	59	50	47	41	39	34	63	57	49	47	41	39	34	47	45	40	38	33	39	38	33	31
	1	73	65	59	54	49	47	41	70	64	57	53	48	46	41	55	52	47	45	40	46	44	40	38
	1.25	80	71	67	61	58	54	48	77	70	65	60	57	53	48	62	59	55	52	47	53	51	47	45
	1.5	85	75	73	66	63	59	53	82	73	71	65	62	58	53	67	63	60	57	52	58	56	51	49
	2	92	80	81	73	72	66	61	89	79	79	71	71	65	60	75	69	68	64	59	65	63	59	56
	2.5	98	84	88	77	79	72	67	94	82	85	76	78	71	66	80	74	74	69	65	71	68	64	62
	3	101	86	92	80	84	75	71	97	85	89	79	82	74	70	84	77	78	73	69	74	71	68	65
	4	105	90	98	85	91	80	76	101	88	95	83	89	79	76	89	81	84	78	74	80	76	73	70
5	108	92	102	87	96	84	80	104	90	98	86	93	83	79	92	84	88	81	78	83	79	77	74	
7	112	94	107	91	102	88	85	107	92	103	89	99	87	84	96	87	93	85	83	87	83	81	78	
10	114	96	111	93	107	91	89	110	94	107	92	103	90	88	99	90	97	88	86	91	86	84	82	

配光曲線

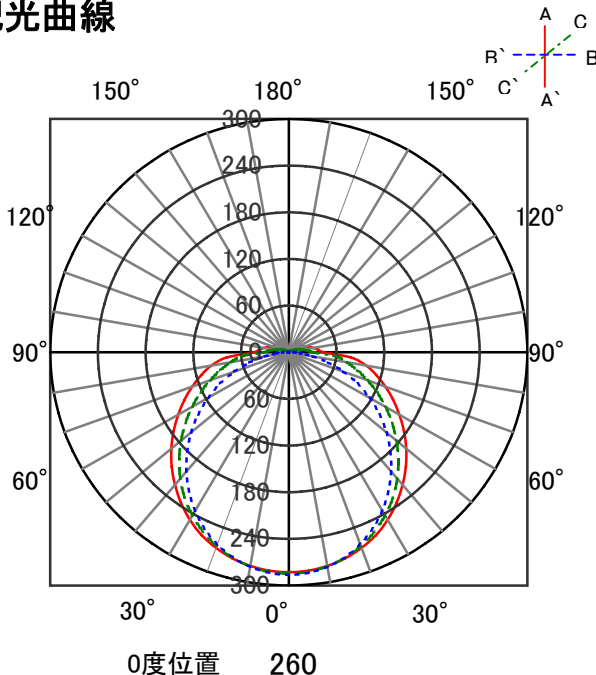

直射水平面照度

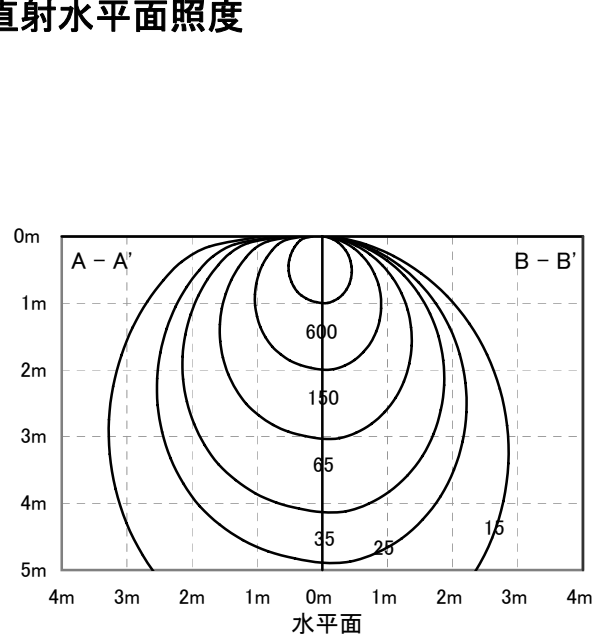

ECOHiLUX照明器具 配光データシート

意匠図

器具品名	直管形LEDランプ 専用器具 逆富士型	保守率	
器具品番	IRLDFL22FJ	良	0.81
部品品名		中	0.77
部品品番	-	否	0.67
		器具効率	
器具光束	1880lm	上方向	4%
光源	LDFL1000NF-H50	下方向	90%
光源光束	1000lm × 2	全方向	94%

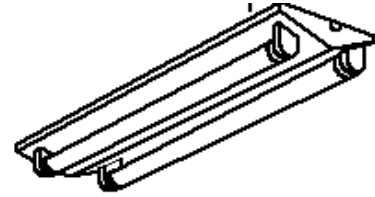

照明率表

		作業面照明率(×0.01)																						
反射率	天井	80								70				50				30		0				
	壁	70	50	30	10	70	50	30	10	70	50	30	10	50	30	10	30	10	30	10	0	0		
床	30	10	30	10	30	10	10	30	10	30	10	30	10	10	30	10	30	10	30	10	10	0		
室 指 数	0.4	40	38	28	27	20	20	16	39	37	27	26	20	20	16	26	25	20	20	16	20	19	15	14
	0.6	55	51	42	39	33	32	27	54	50	41	39	33	32	27	39	38	32	31	27	31	31	27	25
	0.8	65	59	50	47	41	39	34	63	57	49	47	41	39	34	47	45	40	38	33	39	38	33	31
	1	73	65	59	54	49	47	41	70	64	57	53	48	46	41	55	52	47	45	40	46	44	40	38
	1.25	80	71	67	61	58	54	48	77	70	65	60	57	53	48	62	59	55	52	47	53	51	47	45
	1.5	85	75	73	66	63	59	53	82	73	71	65	62	58	53	67	63	60	57	52	58	56	51	49
	2	92	80	81	73	72	66	61	89	79	79	71	71	65	60	75	69	68	64	59	65	63	59	56
	2.5	98	84	88	77	79	72	67	94	82	85	76	78	71	66	80	74	74	69	65	71	68	64	62
	3	101	86	92	80	84	75	71	97	85	89	79	82	74	70	84	77	78	73	69	74	71	68	65
	4	105	90	98	85	91	80	76	101	88	95	83	89	79	76	89	81	84	78	74	80	76	73	70
5	108	92	102	87	96	84	80	104	90	98	86	93	83	79	92	84	88	81	78	83	79	77	74	
7	112	94	107	91	102	88	85	107	92	103	89	99	87	84	96	87	93	85	83	87	83	81	78	
10	114	96	111	93	107	91	89	110	94	107	92	103	90	88	99	90	97	88	86	91	86	84	82	

配光曲線

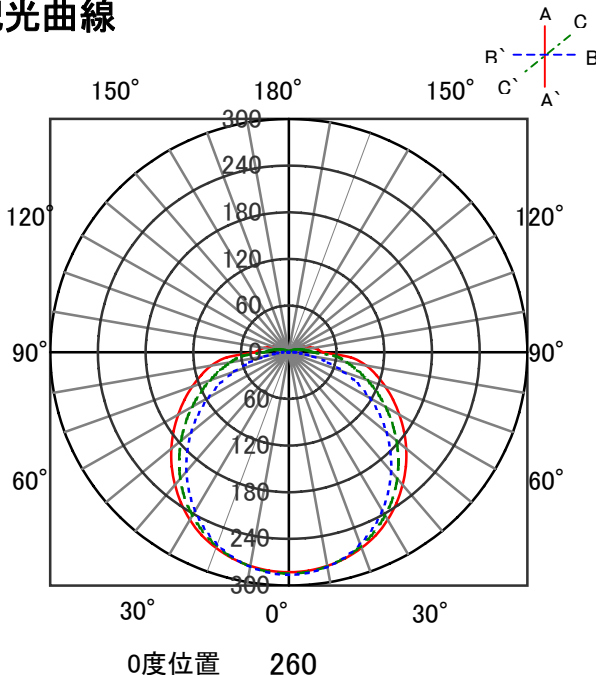

直射水平面照度

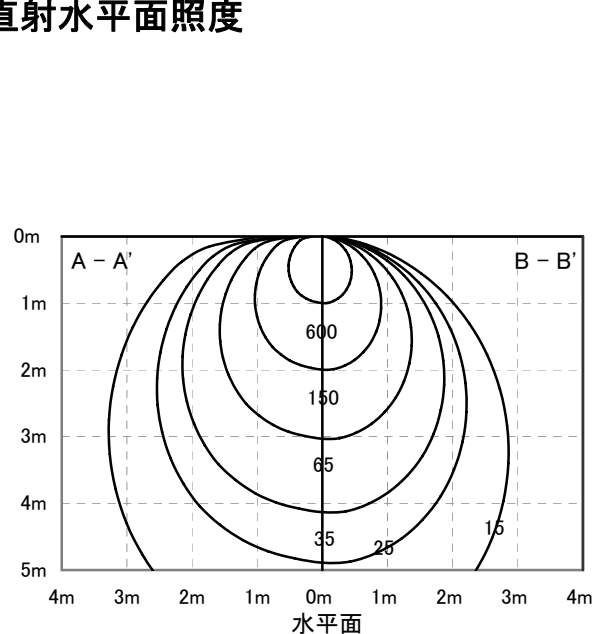

ECOHiLUX照明器具 配光データシート

意匠図

器具品名	直管形LEDランプ 専用器具 逆富士型	保守率	
器具品番	IRLDFL22FJ	良	0.81
部品品名		中	0.77
部品品番	-	否	0.67
		器具効率	
器具光束	1880lm	上方向	4%
光源	LDFL1000DF-H65	下方向	90%
光源光束	1000lm × 2	全方向	94%

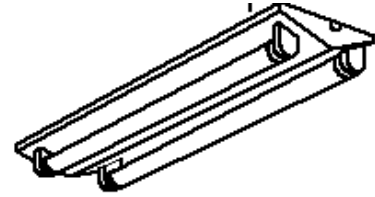

照明率表

反射率	天井	80								70				50				30		0					
		壁		70		50		30		10		70		50		30		10		30		10		0	
	床	30	10	30	10	30	10	10	30	10	30	10	30	10	10	30	10	30	10	10	30	10	10	0	0
室 指 数	0.4	40	38	28	27	20	20	16	39	37	27	26	20	20	16	26	25	20	20	16	20	19	15	14	
	0.6	55	51	42	39	33	32	27	54	50	41	39	33	32	27	39	38	32	31	27	31	31	27	25	
	0.8	65	59	50	47	41	39	34	63	57	49	47	41	39	34	47	45	40	38	33	39	38	33	31	
	1	73	65	59	54	49	47	41	70	64	57	53	48	46	41	55	52	47	45	40	46	44	40	38	
	1.25	80	71	67	61	58	54	48	77	70	65	60	57	53	48	62	59	55	52	47	53	51	47	45	
	1.5	85	75	73	66	63	59	53	82	73	71	65	62	58	53	67	63	60	57	52	58	56	51	49	
	2	92	80	81	73	72	66	61	89	79	79	71	71	65	60	75	69	68	64	59	65	63	59	56	
	2.5	98	84	88	77	79	72	67	94	82	85	76	78	71	66	80	74	74	69	65	71	68	64	62	
	3	101	86	92	80	84	75	71	97	85	89	79	82	74	70	84	77	78	73	69	74	71	68	65	
	4	105	90	98	85	91	80	76	101	88	95	83	89	79	76	89	81	84	78	74	80	76	73	70	
5	108	92	102	87	96	84	80	104	90	98	86	93	83	79	92	84	88	81	78	83	79	77	74		
7	112	94	107	91	102	88	85	107	92	103	89	99	87	84	96	87	93	85	83	87	83	81	78		
10	114	96	111	93	107	91	89	110	94	107	92	103	90	88	99	90	97	88	86	91	86	84	82		

配光曲線

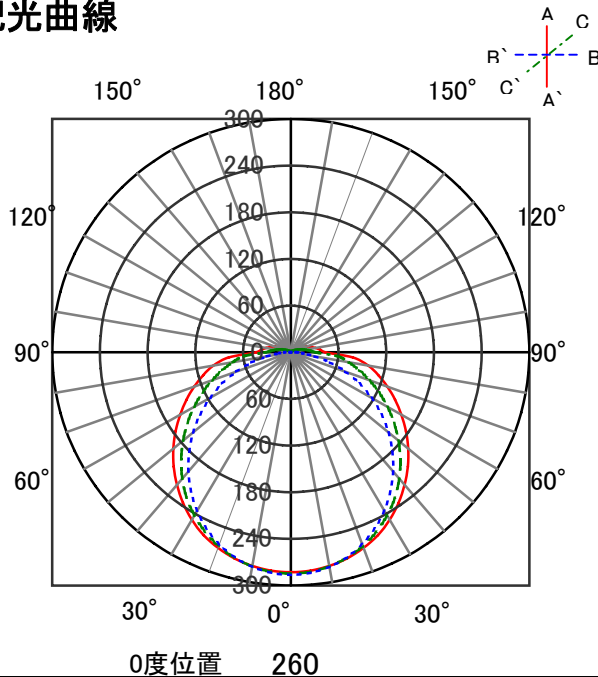

直射水平面照度

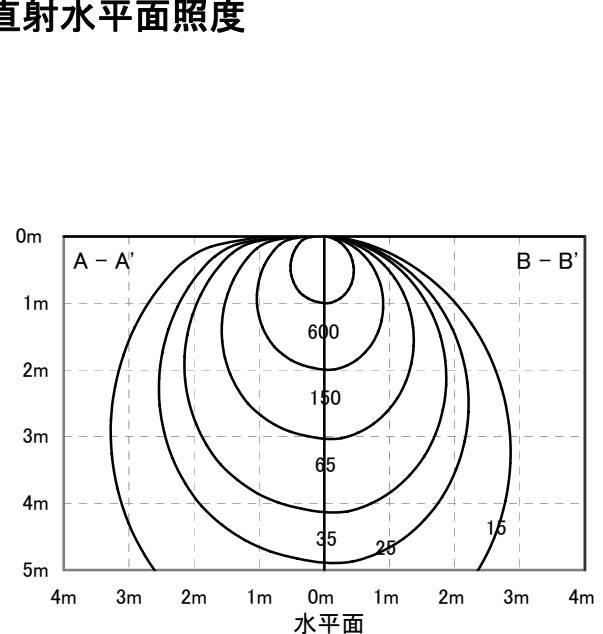

ECOHiLUX照明器具 配光データシート

意匠図

器具品名	直管形LEDランプ 専用器具 逆富士型	保守率	
器具品番	IRLDL22FJ	良	0.81
部品品名		中	0.77
部品品番	-	否	0.67
		器具効率	
器具光束	1880lm	上方向	4%
光源	LDG20S・WW/9/10	下方向	90%
光源光束	1000lm × 2	全方向	94%

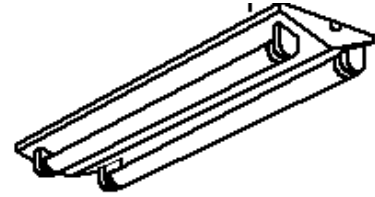

照明率表

		作業面照明率(×0.01)																						
反射率	天井	80								70				50				30		0				
	壁	70	50	30	10	70	50	30	10	70	50	30	10	50	30	10	30	10	30	10	0	0		
床	30	10	30	10	30	10	10	30	10	30	10	30	10	10	30	10	30	10	10	30	10	10	0	
室 指 数	0.4	40	38	28	27	20	20	16	39	37	27	26	20	20	16	26	25	20	20	16	20	19	15	14
	0.6	55	51	42	39	33	32	27	54	50	41	39	33	32	27	39	38	32	31	27	31	31	27	25
	0.8	65	59	50	47	41	39	34	63	57	49	47	41	39	34	47	45	40	38	33	39	38	33	31
	1	73	65	59	54	49	47	41	70	64	57	53	48	46	41	55	52	47	45	40	46	44	40	38
	1.25	80	71	67	61	58	54	48	77	70	65	60	57	53	48	62	59	55	52	47	53	51	47	45
	1.5	85	75	73	66	63	59	53	82	73	71	65	62	58	53	67	63	60	57	52	58	56	51	49
	2	92	80	81	73	72	66	61	89	79	79	71	71	65	60	75	69	68	64	59	65	63	59	56
	2.5	98	84	88	77	79	72	67	94	82	85	76	78	71	66	80	74	74	69	65	71	68	64	62
	3	101	86	92	80	84	75	71	97	85	89	79	82	74	70	84	77	78	73	69	74	71	68	65
	4	105	90	98	85	91	80	76	101	88	95	83	89	79	76	89	81	84	78	74	80	76	73	70
5	108	92	102	87	96	84	80	104	90	98	86	93	83	79	92	84	88	81	78	83	79	77	74	
7	112	94	107	91	102	88	85	107	92	103	89	99	87	84	96	87	93	85	83	87	83	81	78	
10	114	96	111	93	107	91	89	110	94	107	92	103	90	88	99	90	97	88	86	91	86	84	82	

配光曲線

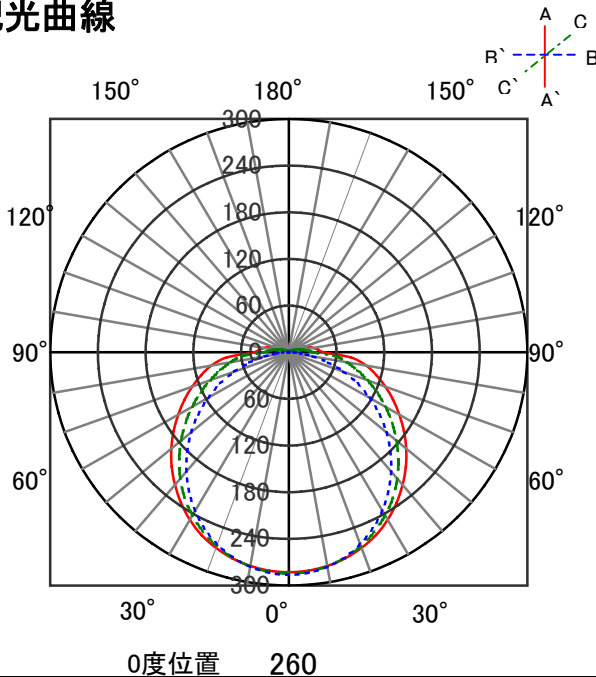

直射水平面照度

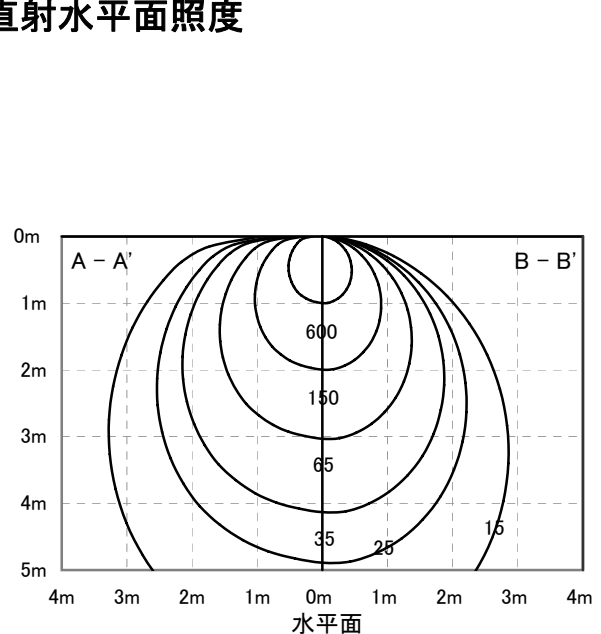

ECOHiLUX照明器具 配光データシート

意匠図

器具品名	直管形LEDランプ 専用器具 逆富士型	保守率	
器具品番	IRLDL22FJ	良	0.81
部品品名		中	0.77
部品品番	-	否	0.67
		器具効率	
器具光束	1880lm	上方向	4%
光源	LDG20S・W/9/10	下方向	90%
光源光束	1000lm × 2	全方向	94%

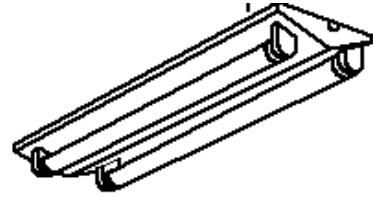

照明率表

反射率	天井	80								70				50				30		0				
		壁	70		50		30		10		70	50	30	10	50	30	10	10	30	10	10	0	0	
	床	30	10	30	10	30	10	10	30	10	30	10	30	10	10	30	10	30	10	30	10	10	0	0
室 指 数	0.4	40	38	28	27	20	20	16	39	37	27	26	20	20	16	26	25	20	20	16	20	19	15	14
	0.6	55	51	42	39	33	32	27	54	50	41	39	33	32	27	39	38	32	31	27	31	31	27	25
	0.8	65	59	50	47	41	39	34	63	57	49	47	41	39	34	47	45	40	38	33	39	38	33	31
	1	73	65	59	54	49	47	41	70	64	57	53	48	46	41	55	52	47	45	40	46	44	40	38
	1.25	80	71	67	61	58	54	48	77	70	65	60	57	53	48	62	59	55	52	47	53	51	47	45
	1.5	85	75	73	66	63	59	53	82	73	71	65	62	58	53	67	63	60	57	52	58	56	51	49
	2	92	80	81	73	72	66	61	89	79	79	71	71	65	60	75	69	68	64	59	65	63	59	56
	2.5	98	84	88	77	79	72	67	94	82	85	76	78	71	66	80	74	74	69	65	71	68	64	62
	3	101	86	92	80	84	75	71	97	85	89	79	82	74	70	84	77	78	73	69	74	71	68	65
	4	105	90	98	85	91	80	76	101	88	95	83	89	79	76	89	81	84	78	74	80	76	73	70
5	108	92	102	87	96	84	80	104	90	98	86	93	83	79	92	84	88	81	78	83	79	77	74	
7	112	94	107	91	102	88	85	107	92	103	89	99	87	84	96	87	93	85	83	87	83	81	78	
10	114	96	111	93	107	91	89	110	94	107	92	103	90	88	99	90	97	88	86	91	86	84	82	

配光曲線

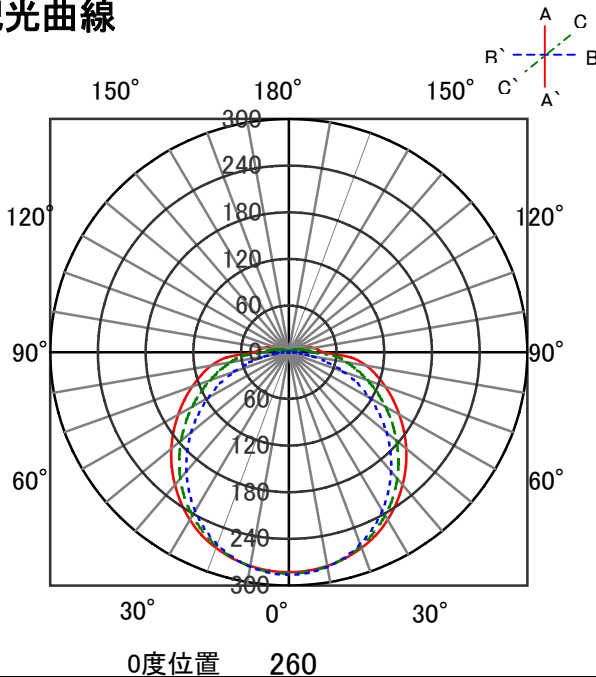

直射水平面照度

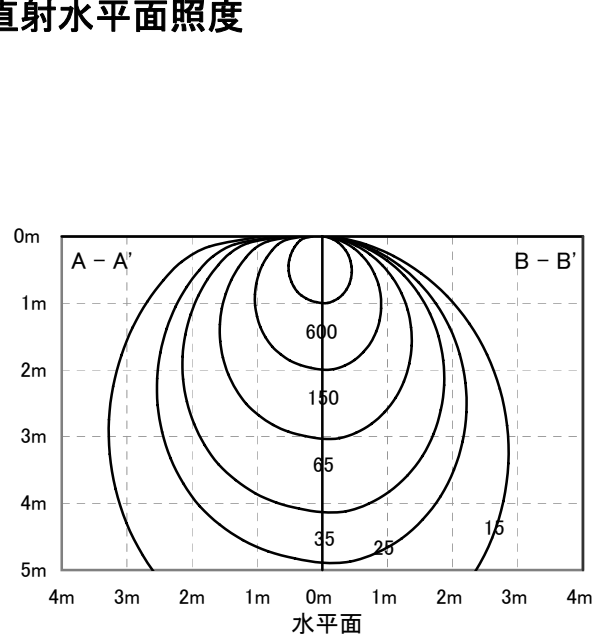

ECOHiLUX照明器具 配光データシート

意匠図

器具品名	直管形LEDランプ 専用器具 逆富士型	保守率	
器具品番	IRLDL22FJ	良	0.81
部品品名		中	0.77
部品品番	-	否	0.67
		器具効率	
器具光束	1880lm	上方向	4%
光源	LDG20S・N/8/10	下方向	90%
光源光束	1000lm × 2	全方向	94%

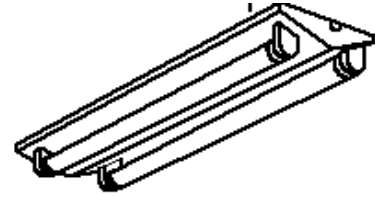

照明率表

		作業面照明率(×0.01)																						
反射率	天井	80								70				50				30		0				
	壁	70	50	30	10	70	50	30	10	70	50	30	10	50	30	10	30	10	30	10	10	0		
床	30	10	30	10	30	10	10	30	10	30	10	30	10	10	30	10	30	10	30	10	10	0		
室 指 数	0.4	40	38	28	27	20	20	16	39	37	27	26	20	20	16	26	25	20	20	16	20	19	15	14
	0.6	55	51	42	39	33	32	27	54	50	41	39	33	32	27	39	38	32	31	27	31	31	27	25
	0.8	65	59	50	47	41	39	34	63	57	49	47	41	39	34	47	45	40	38	33	39	38	33	31
	1	73	65	59	54	49	47	41	70	64	57	53	48	46	41	55	52	47	45	40	46	44	40	38
	1.25	80	71	67	61	58	54	48	77	70	65	60	57	53	48	62	59	55	52	47	53	51	47	45
	1.5	85	75	73	66	63	59	53	82	73	71	65	62	58	53	67	63	60	57	52	58	56	51	49
	2	92	80	81	73	72	66	61	89	79	79	71	71	65	60	75	69	68	64	59	65	63	59	56
	2.5	98	84	88	77	79	72	67	94	82	85	76	78	71	66	80	74	74	69	65	71	68	64	62
	3	101	86	92	80	84	75	71	97	85	89	79	82	74	70	84	77	78	73	69	74	71	68	65
	4	105	90	98	85	91	80	76	101	88	95	83	89	79	76	89	81	84	78	74	80	76	73	70
5	108	92	102	87	96	84	80	104	90	98	86	93	83	79	92	84	88	81	78	83	79	77	74	
7	112	94	107	91	102	88	85	107	92	103	89	99	87	84	96	87	93	85	83	87	83	81	78	
10	114	96	111	93	107	91	89	110	94	107	92	103	90	88	99	90	97	88	86	91	86	84	82	

配光曲線

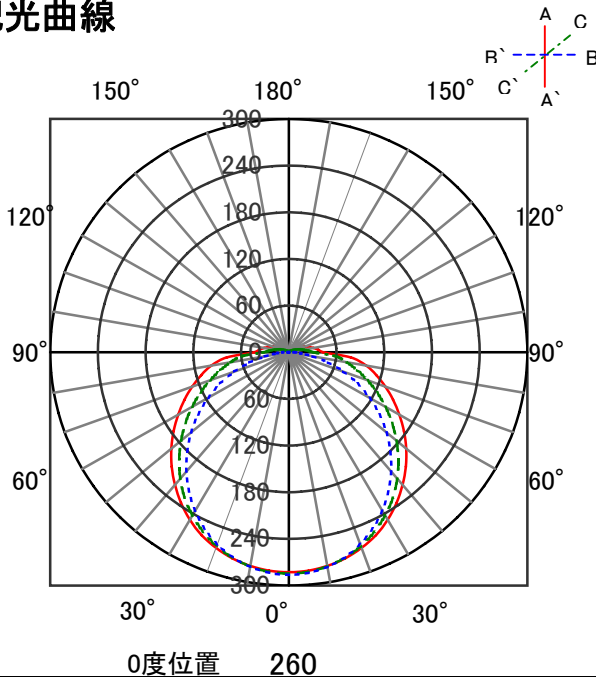

直射水平面照度

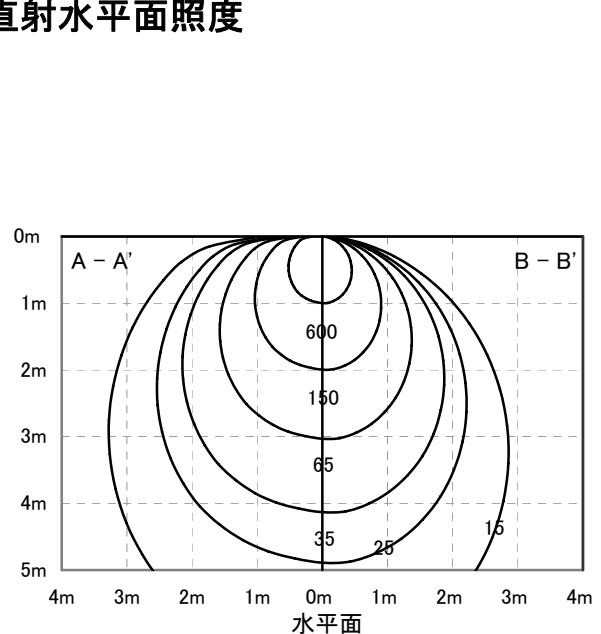

ECOHiLUX照明器具 配光データシート

意匠図

器具品名	直管形LEDランプ 専用器具 逆富士型	保守率	
器具品番	IRLDL22FJ	良	0.81
部品品名		中	0.77
部品品番	-	否	0.67
		器具効率	
器具光束	1880lm	上方向	4%
光源	LDG20S・D/9/10	下方向	90%
光源光束	1000lm × 2	全方向	94%

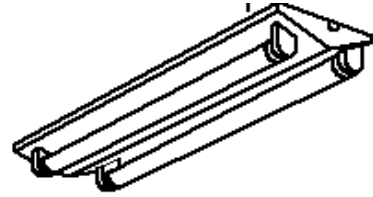

照明率表

		作業面照明率(×0.01)																							
反射率	天井	80								70				50				30		0					
	壁	70	10	30	10	30	10	10	10	70	10	30	10	30	10	10	30	10	30	10	10	30	10	10	0
室 指 数	0.4	40	38	28	27	20	20	16	39	37	27	26	20	20	16	26	25	20	20	16	20	19	15	14	
	0.6	55	51	42	39	33	32	27	54	50	41	39	33	32	27	39	38	32	31	27	31	31	27	25	
	0.8	65	59	50	47	41	39	34	63	57	49	47	41	39	34	47	45	40	38	33	39	38	33	31	
	1	73	65	59	54	49	47	41	70	64	57	53	48	46	41	55	52	47	45	40	46	44	40	38	
	1.25	80	71	67	61	58	54	48	77	70	65	60	57	53	48	62	59	55	52	47	53	51	47	45	
	1.5	85	75	73	66	63	59	53	82	73	71	65	62	58	53	67	63	60	57	52	58	56	51	49	
	2	92	80	81	73	72	66	61	89	79	79	71	71	65	60	75	69	68	64	59	65	63	59	56	
	2.5	98	84	88	77	79	72	67	94	82	85	76	78	71	66	80	74	74	69	65	71	68	64	62	
	3	101	86	92	80	84	75	71	97	85	89	79	82	74	70	84	77	78	73	69	74	71	68	65	
	4	105	90	98	85	91	80	76	101	88	95	83	89	79	76	89	81	84	78	74	80	76	73	70	
5	108	92	102	87	96	84	80	104	90	98	86	93	83	79	92	84	88	81	78	83	79	77	74		
7	112	94	107	91	102	88	85	107	92	103	89	99	87	84	96	87	93	85	83	87	83	81	78		
10	114	96	111	93	107	91	89	110	94	107	92	103	90	88	99	90	97	88	86	91	86	84	82		

配光曲線

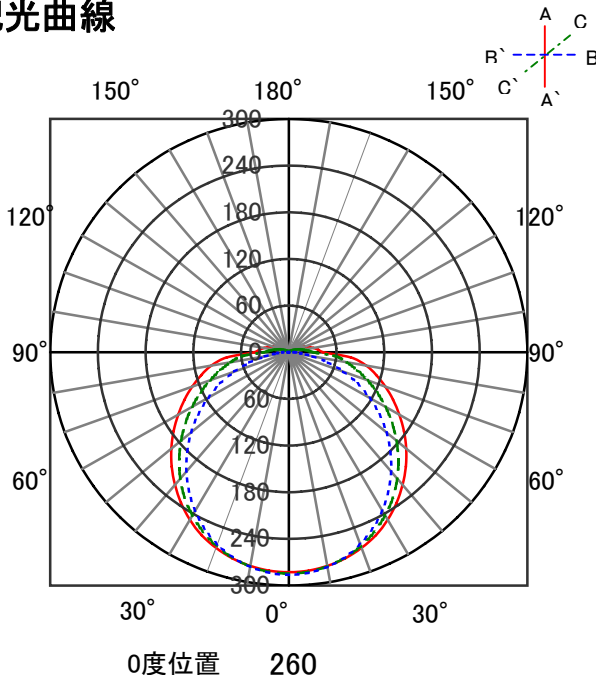

直射水平面照度

